

# ECoSDetector

## Instruction manual

1. Edition, June 2011

50094 ECoSDetector

50096 ECoSDetector Standard



<b>1. EG - Declaration of conformity</b> .....	<b>3</b>	8.3. Finding an ECoSDetector .....	12
<b>2. WEEE-Declaration</b> .....	<b>3</b>	8.4. Administration of several ECoSDetectors.....	12
<b>3. Important Notes – Please read first</b> .....	<b>3</b>	<b>9. Utilising feedback information</b> .....	<b>13</b>
3.1. Scope of delivery.....	3	9.1. Setting routes .....	13
<b>4. Occupancy detection and its function</b> .....	<b>4</b>	9.2. Track control diagram .....	13
4.1. Contact with the common conductor .....	4	<b>10. Technical data</b> .....	<b>14</b>
4.2. Current sensors (not with ECoSDetector Standard) .....	4	10.1. Technical data ECoSDetector.....	14
4.3. RailCom® feedback (not with ECoSDetector Standard).4	4	10.2. Technical data ECoSDetector Standard.....	14
<b>5. General properties</b> .....	<b>5</b>	<b>11. Support and Assistance</b> .....	<b>14</b>
5.1. Properties of the ECoSDetector Standard .....	5	<b>12. Warranty Certificate</b> .....	<b>15</b>
5.2. Properties of the ECoSDetector.....	5		
<b>6. Connecting it to the tracks</b> .....	<b>6</b>		
6.1. Common contacts .....	6		
6.1.1. Jumpers .....	6		
6.1.2. 3-rail track system (contact track section).....	6		
6.1.3. Track switches.....	7		
6.1.4. Reed contacts .....	7		
6.1.5. Externally supplied switches .....	7		
6.2. Current guard (not for ECoSDetector Standard) .....	8		
6.2.1. Jumpers .....	8		
6.2.2. 2-rail track system.....	8		
6.2.3. 3-rail track system.....	9		
6.3. RailCom® feedback (no for ECoSDetector Standard) ....	9		
6.4. Two booster sectors on one ECoSDetector .....	10		
<b>7. Connecting to the command station</b> .....	<b>10</b>		
<b>8. Configuration on the command station</b> .....	<b>11</b>		
8.1. Name and indenture number .....	11		
8.2. Feedback status .....	12		

Copyright 1998 - 2011 by ESU electronic solutions ulm GmbH & Co KG. Mistakes, changes resulting in technical advancement, availability and all other rights reserved. Electrical and mechanical characteristics, dimensions and sketches are subject to change without prior notice. ESU may not be held responsible for any damage or consequential loss or damage caused by inappropriate use of the product, abnormal operating conditions, unauthorised modifications to the product, etc. Not suitable for children under 14 years of age. Inappropriate use may result in injury due to sharp points and edges.

Märklin® is a registered trademark of Gebr. Märklin® und Cie. GmbH, Göppingen, Germany. RailCom® is a registered trademark of Lenz Elektronik GmbH, Giessen. RailComPlus® is a registered trademark of Lenz Elektronik GmbH, Giessen. All other trademarks are the property of their respective legal owners. According to its policy ESU electronic solutions ulm GmbH & Co KG continues to develop its products. Therefore ESU reserves the right to implement changes and improvements to any of the products listed in the ESU documentation. Duplication and reproduction of this documentation in any shape or form requires prior written consent from ESU.

# Important notes

## 1. EG - Declaration of conformity

We, ESU electronic solutions ulm GmbH & Co. KG, Edisonallee 29, D-89231 Neu-Ulm, Germany, declare in sole responsibility that the product

Product description: ECoSDetector

Part number: 50094, 50096

complies with all relevant regulations of the Directive for Electromagnetic Compatibility (2004/108/EG). The following harmonised standards have been applied:

EN 55014-1:2006 + A1:2009: Electromagnetic Compatibility - requirements for household appliances, electric tools, and similar apparatus - Part 1: Emission - Product

EN 55014-2:1997 + A1:2001 + A2:2008: Electromagnetic Compatibility - Requirements for household appliances, electric tools, and similar apparatus - Part 2: Immunity - Product family standard.

## 2. WEEE-Declaration

Disposal of obsolete electrical and electronic equipment (as practised in the European Union and other European countries with dedicated collection systems).



This mark on the product, the packaging or the relevant documentation indicates that this product must not be treated like household waste. Instead this product should be disposed of at a suitable collection point for recycling of electrical and electronic appliances. Thus you contribute to avoid

negative impact on the environment and people's health that could be caused by inappropriate disposal. Recycling of materials contributes to preserve our natural resources. For more information regarding recycling of this product, please contact your local authority, your waste collection service or the dealer / shop where you purchased this product.

## 3. Important Notes – Please read first

We congratulate you to your purchase of an ESU ECoSDetector feedback module. This manual provides step by step information on the various options of use of this device. Therefore we have one request:

Please read this manual carefully prior to commissioning. Although the circuit board is quite robust incorrect wiring could lead to damage or destruction of the module. If in doubt, please refrain from any "expensive" experiments.



- The ECoSDetector is solely intended for use on electric model train layouts. It may only be operated with the components described in this manual. Any other use as described in this manual is not permitted.
- All electrical work such as wiring the module may only be carried out when power is turned off.
- Avoid any impact load or pressure against the module.
- Keep away from wet conditions or humidity.
- The circuit board may not get into contact with any metal objects or electrical conductors. This is particularly true for the track signal.
- Never let your trains run unattended.

### 3.1. Scope of delivery

Please check if the following parts are in the packaging of your ECoSDetector:

1x ECoSDetector respectively ECoSDetector Standard

1x Accessory bag (with 4 nos. 4-way terminal blocks, 2 nos. 2-way terminal blocks)

1x ECoSlink connecting cable

1x Manual (which you are reading right now)

## 4. Occupancy detection and its function

Occupancy detection systems are required in order to provide information regarding the track status. A track can either be occupied or unoccupied.

This information is useful for parts of your layout that you cannot directly see from your position (e.g.: storage yards) or if you wish to display the track status on your track control diagram.

Occupancy feedback is an essential prerequisite for any partial or fully automatic operation: the automated system respectively the computer needs information in order to decide if a certain train may enter a certain track or which route should be switched.

Furthermore modern occupancy detection systems can provide information about which vehicle is located in a certain track sector.

Subject to the track system and the application there are three methods of how track occupancy can be determined.

### 4.1. Contact with the common conductor

The simplest form of feedback is to use reed contacts closing the circuit to the common conductor, light barriers or photo sensors, track contacts or track sections with integral switch contacts. With the three-rail-system the occupancy detection is often realised by insulating one outer track from the rest of the layout and thus use is as an electrical switch. This corresponds with the well known original "s88 configuration". The ECoSDetector as well as the ECoSDetector Standard support this mode.

### 4.2. Current sensors (not with ECoSDetector Standard)

With this method suitable for all track systems the detector measures the current flowing through the respective track sector. Every electric load on the track causes a current flow. "A current flow" is therefore equivalent to the "occupied" status of the track. Therefore the status "there is no current flowing" means the track is unoccupied.

All loads must draw a minimum current of about 1mA (0,001A) in order to assure reliable operation of this current measuring system.



Commercially available resistor axles with about 18 kOhm can just be detected provided the tracks are clean and the wheels sit properly on the tracks. We recommend equipping two axles per car with resistors. The resulting resistance value of about 9 kOhm is reliably detected.

In case of an interruption of the track voltage (e.g.: due to a short circuit or an emergency stop with power out) there will be no current flow and occupancy detection is not possible any longer. In order to prevent any incorrect "unoccupied" feedback to the command station the occupancy status is frozen for the duration of the power failure.

As soon as the track voltage is turned on again the occupancy status is monitored and current information is transmitted to the command station.

### 4.3. RailCom® feedback (not with ECoSDetector Standard)

Decoders equipped with RailCom® or RailComPlus® can provide the locomotive number to the ECoSDetector which in turn will transmit it to the command station. Finally we can determine precisely which locomotive is located on which track. The ECoSDetector must read the current flow in the track sector in order to read out the RailCom feedback.

## 5. General properties

ECoSDetector feedback modules are suitable for operation with the ESU command stations ECoS 50000, ECOS 50200 as well as with the Central Station 60212 "Reloaded" with ESU Update.



The command station must have firmware version 3.4.1 or higher in order to be able to operate the ECoSDetector modules.

ECoSDetector modules detect track occupancy and transmit these to the ECoSlink terminal of the command station. The "occupied" information can either be displayed on the track control diagram, for activating routes or to pass it on to a computer via the appropriate interface.

All ECoSDetector modules are automatically recognised by the command station and integrated into the system. They can be wired in any sequence can be adapted to your layout. The ECoS-Detector is fully updateable. New firmware files are automatically downloaded from the ECoS command station if a newer version has become available.

The ECoSDetector occupancy detector can monitor up to 16 track sectors. Internally they are subdivided into two groups of 8 each that can be wired to one or two booster sectors. All feedback inputs are galvanically separated from the track voltage by means of optoelectronic couplers. This practically avoids any risk of short circuits while the feedback functions very reliably.

The monitored track sectors are polled cyclically by a 32 Bit micro controller thus avoiding any noticeable delays of the status feedback. In order to avoid any wrong occupancy feedback all sectors act with a certain delay. This works as follows:

- **Switch-on delay:** Is a track occupancy detected it must remain on for at least 4 milliseconds before this signal is considered valid and before it is transmitted.
- **Switch-off delay:** If a previously occupied track is detected as unoccupied the signal is only transmitted after a delay of 200 milliseconds. Should this track sector during this delay period be re-

ported as "occupied" once again, there will be no feedback signal and the switch-off delay starts again. Once the track is confirmed as "unoccupied" and the switch-off delay period has passed the "unoccupied" status will be reported to the command station. Short interruptions - perhaps caused by poor contact between the wheels and the track - can easily be filtered with this method.

ECoSDetector modules can be operated in parallel to s88 feedback modules at your command station.

### 5.1. Properties of the ECoSDetector Standard

The ECoSDetector Standard has 16 feedback inputs that work as „common“ contacts. An ECoSDetector Standard has to be wired exactly in the same manner as an s88 module and can fully replace it. Due to the robust ECoSlink feedback bus the feedback is far more reliable.

The ECoSDetector Standard is mainly designed for 3-rail layouts or for layouts with reed contacts.

### 5.2. Properties of the ECoSDetector

The ECoSDetector has 16 feedback inputs. Each of them can be configured either as a "common" contact or as a current guard by means of a jumper. In addition, four of the 16 feedback inputs are suitable for RailCom® feedback. If the inputs are configured as current guards the maximum permitted current is 3 A per track sector.

Due to its flexibility the ECoSDetector is suitable for both 3-rail and 2-rail operation and for all model train gauges.

# Connecting it to the tracks

## 6. Connecting it to the tracks

In this paragraph we show you how to wire the ECoSDetector module to the tracks. In the figures the ECoSDetector module is shown; wiring the ECoSDetector Standard is identical. However, on the ECoSDetector Standard there are no jumpers.

### 6.1. Common contacts

As feedback inputs configured as common inputs you may connect all contacts that switch the input to the common conductor (often this is the "brown" digital feeder). Thus you can switch either against the terminal marked "0" or against the terminal 0 (brown) at the track.

#### 6.1.1. Jumpers

The ECoSDetector has a jumper for each feedback input for configuring the input either as common contact or as current guard.

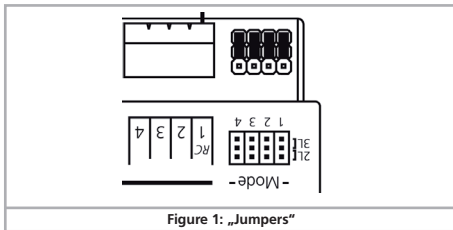

If you wish to use the input as common contact place the corresponding jumper to the outer position "3L". In figure 1 all inputs are configured as common contacts. But, of course, you may configure each input individually.

### 6.1.2. 3-rail track system (contact track section)

Figure 2 shows how to wire a contact track in a 3-rail system.

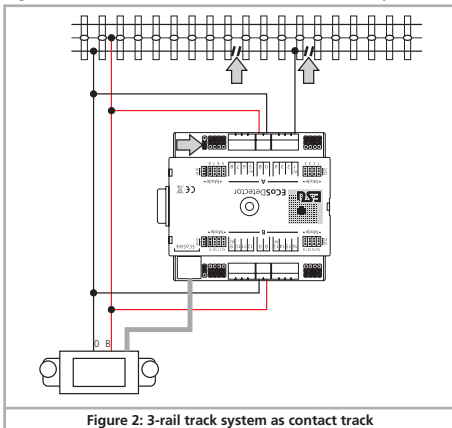

- Wire the inputs „0“ and „B“ of the ECoSDetector with the appropriate booster output. In example 2 both feedback groups „A“ and „B“ are supplied from the same booster. Therefore the terminals „0“ and „B“ on both sides of the ECoSDetector must be connected with each other. If you use a separate booster for the inputs of group „B“ (feedback inputs 9 through 16) the ECoSDetector has to be wired as described in chapter 6.4.
- Connect the insulated sector of the track to be monitored to one of the input terminals "1" to "16" of the ECoSDetector module.

## Connecting it to the tracks

The occupancy feedback will work trouble free if the track sector to be monitored has been isolated at both ends.



Do not forget to set the jumpers of the ECoSDetector correctly. This is not necessary with the ECoSDetector Standard.



Please keep the wiring between the feedback module and the track sector to be monitored as short as possible. If the wires are very long and installed close to each other it may result in an unintentional data transfer between the wires. Even though only one track sector is occupied several feedback inputs may report "occupied".

### 6.1.3. Track switches

Figure 3 shows how to connect a Märklin® track switch. Please note that this track switch functions directionally!

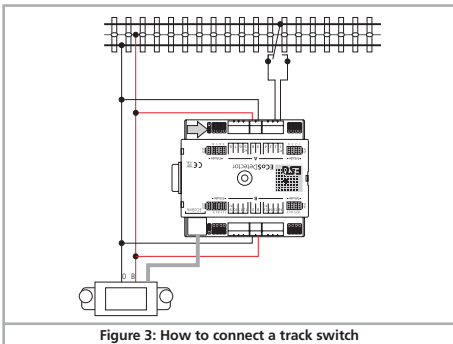

Figure 3: How to connect a track switch

### 6.1.4. Reed contacts

Figure 4 shows how to wire a reed contact. Please make sure that you install sufficiently strong magnets at the underside of your vehicles to assure reliable function even at high speeds!

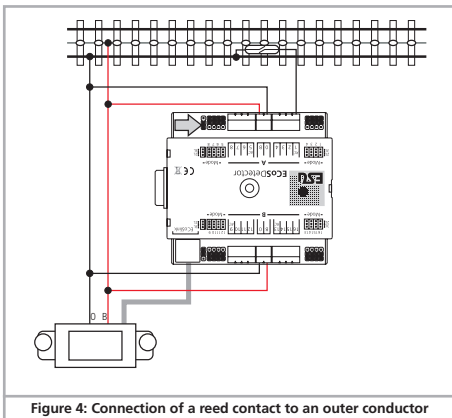

Figure 4: Connection of a reed contact to an outer conductor

### 6.1.5. Externally supplied switches

The ECoSDetector also works without direct connection to the track by means of commercially available switches or push buttons. In this case you must supply the ECoSDetector with a DC voltage (!) ranging between 12V and 22V. Figure 5 shows how it is done:

## Connecting it to the tracks

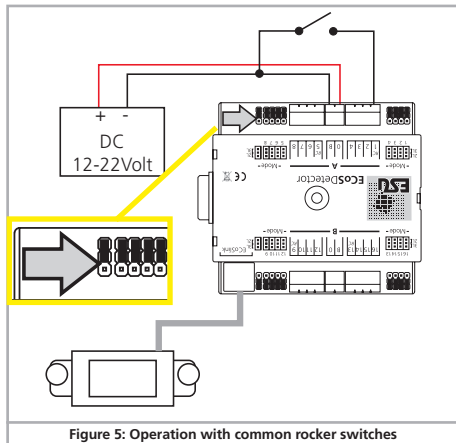

Figure 5: Operation with common rocker switches

Please note that the jumper for the power supply (marked with an arrow in figure 5 at the top left) must be set to the outer position for this operating mode.

### 6.2. Current guard (not for ECoSDetector Standard)

Each of the 16 feedback inputs of the ECoSDetector can be configured as current guard. This is the most reliable type of feedback and is suitable both for 3-rail systems and 2-rail systems.



If you have a choice (whenever you rewire your layout), select the current guard option since the feedback function is far more reliable than the known common contacts.



Please make sure that you always cut the "correct" track and thus the correct pole of the digital track voltage when isolating the track sectors. In figure 7 it is shown that the conductor "B" (red) must be isolated. This must be done in the same way for the entire layout.

### 6.2.1. Jumpers

The ECoSDetector has a jumper for each feedback input in order to configure this input either as common contact or as current guard.

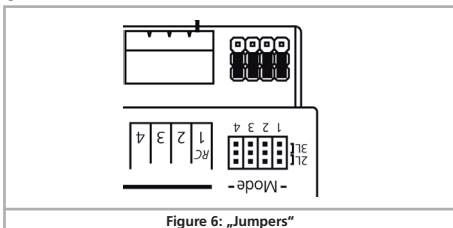

Figure 6: „Jumpers“

If you wish to use an input as current guard place the jumper onto the inner position "2L". In figure 6 the inputs 1 to 4 are configured as current guards. But, of course, you can configure each input individually.

### 6.2.2. 2-rail track system

- Connect the inputs "0" and "B" of the ECoSDetector with the appropriate booster output. In the example in figure 7 both feedback groups "A" and "B" are supplied by the same booster. Therefore the terminals "0" and "B" on both sides of the ECoSDetector must be connected with each other. If you use a separate ECoS-Boost for group "B" (feedback inputs 9 through 16) then the module must be wired as described in chapter 6.4.
- Connect the feedback terminals "1" through "16" with the corresponding track sector which must be insulated from the rest of the layout at both ends (!).



## Connecting it to the tracks

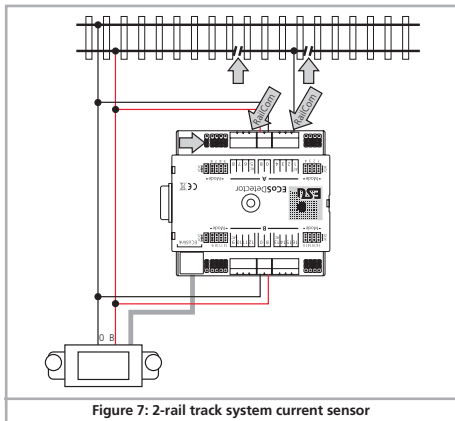

Figure 7: 2-rail track system current sensor



Otherwise a short circuit would occur every time a locomotive or car bridges the gap between different sectors.

### 6.2.3. 3-rail track system

The current guard mode is also recommended for the 3-rail track system. Cut the centre conductor of the track sector to be monitored at both (!) ends and connect it to the feedback input of the ECoSDetector.

- Connect the inputs „0“ and „B“ of the ECoSDetector with the appropriate booster output. In the example shown in figure 8 both feedback groups „A“ and „B“ are supplied by the same booster. Therefore the terminals “0” and “B” on both sides of the ECoSDetector must be connected with each other. If you use a separate ECoSBoost for group “B” (feedback inputs 9 through 16) then the

module must be wired as described in chapter 6.4.

- Connect the feedback terminals “1” through “16” with the corresponding track sector (isolated centre conductor) which must be insulated from the rest of the layout at both ends (!).

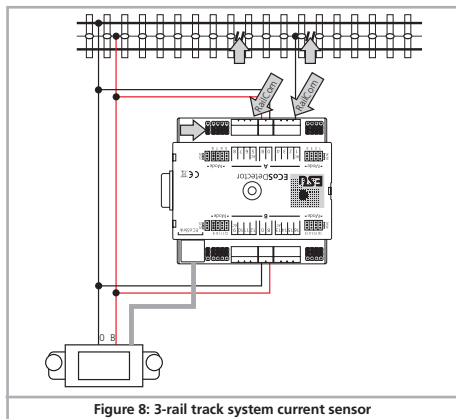

Figure 8: 3-rail track system current sensor

### 6.3. RailCom® feedback (no for ECoSDetector Standard)

In addition to the conventional occupancy feedback (“track occupied” or “track unoccupied”) the inputs 1, 5, 9 and 13 can read out the address of the locomotive locate on this particular track sector. A pre-condition for this mode is that the locomotive decoder supports RailCom® or RailComPlus® and that this function is also activated in the decoder. Only then the locomotive decoder

## Connecting to the command station

will transmit its address continuously and thus enables the ECoS-Detector to receive it and to transmit it to the command station. In order to enable the RailCom® feedback configure the corresponding output as described in chapter 6.4 to current guard mode and make sure that all ESU decoders have the latest firmware.

**i** If the feedback input is configured as common contact the RailCom® feedback cannot work.

### 6.4. Two booster sections on one ECoSDetector

The feedback inputs of the ECoSDetector are divided into two groups: "A" (inputs 1 through 8) and "B" (inputs 9 through 16). These two groups can be supplied by two different booster sections. Each feedback group has terminals "B" and "0" to be connected to the booster outputs that supplies power for the track sector to be monitored. In figure 9 we show an example of how to wire a 3-rail system where both feedback groups receive power from their own separate power supply (group "A" form the ECoS and group "B" from a separate ECoSBoost).

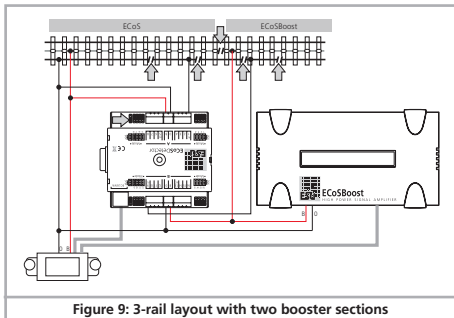

## 7. Connecting to the command station

The ECoSDetector is wired with the supplied ECoSlink cable directly to one of the three ECoSlink sockets of your ECoS. The power supply for each ECoSDetector is provided by the ECoS command station. To which socket you connect which ECoSDetector has no relevance regarding the internal numbering sequence of the feedback inputs. After connecting it each ECoSDetector is automatically detected by the command station and linked to the system.

To be able to utilize the feedback inputs successfully you only have to set a few things in the setup menu on the command station.

**i** If you wish to use more than three ECoSDetector modules or if the supplied cable is too short you should extend the ECoSlink bus with the aid of the ECoSlink-Terminal (ESU part number 50093). The bus can be extended up to 100 meters. Due to the bus topology an extension of the supplied ECoSlink cable is not possible!

After connecting the ECoSDetector successfully the status LED a) must be lit continuously. The button b) can be used for easy identification of the ECoSDetector module.

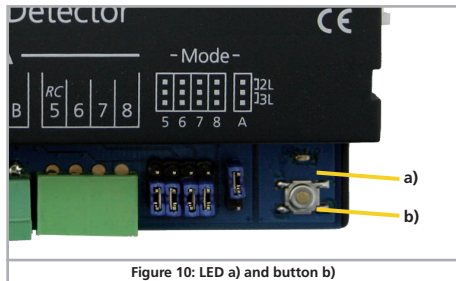

## 8. Configuration on the command station

After connecting the ECoSDetector to the command station the module is automatically detected and linked to the system.



Please make sure that your ECoS has firmware 3.4.1 or higher. Otherwise the ECoSDetector is not recognised.

The configuration takes place on the command station. Each ECoSDetector is displayed with its name in a list called "ECoSLink devices".

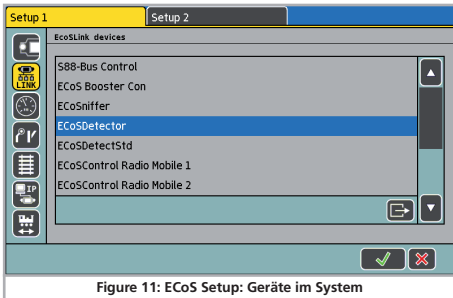

Figure 11: ECoS Setup: Geräte im System

In figure 11 the "ECoSDetector" is displayed by its name. This is the factory default value and should be changed by you as soon as you have more than one ECoSDetector module.



If you wish to use more than one ECoSDetector module it is best to connect them one after another. This practically eliminates the possibility of confusing the modules during configuration.

### 8.1. Name and indenture number



Select the first ECoSDetector from the list as shown in figure 11 and press "Edit". A configuration dialogue opens for this ECoSDetector module.

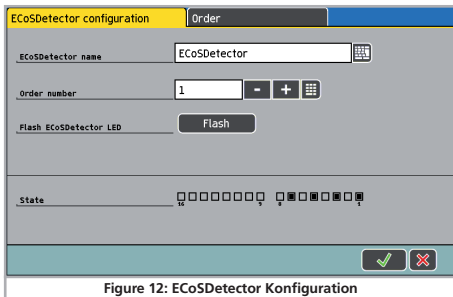

Figure 12: ECoSDetector Konfiguration

**ECoSDetector Name:** Assign a distinct name for each module, e.g.: "Main Station" or "Storage Yard" to assure that you always know its function respectively the part of your layout that is monitored by it.

**ECoSDetector Number:** In order to enable operation of the ECoSDetector parallel to the known s88 feedback modules each ECoSDetector must have a "number" similar to the s88 modules. In this manner it is easily possible to differentiate between the individual modules. The number can be any number between 1 and 100. When using several ECoSDetector modules it is not absolutely necessary to use continuous numbers. There may be gaps in your numbering sequence.

## 8.2. Feedback status

For testing purposes it is often helpful to indicate the actual occupancy status by a visual display. This is possible in the configuration menu. The status “occupied” is indicated for each feedback input by “filled square” on the touch panel of the command station.

## 8.3. Finding an ECoSDetector

After pressing the screen button “Blinking” in the configuration dialogue (also refer to figure 12) the LED of the ECoSDetector starts blinking rhythmically. This makes it far easier for you to find the module.

Alternately you can press the button on the ECoSDetector at any time. A dialogue window will open on the ECoS screen that display both name and indenture number of the module.

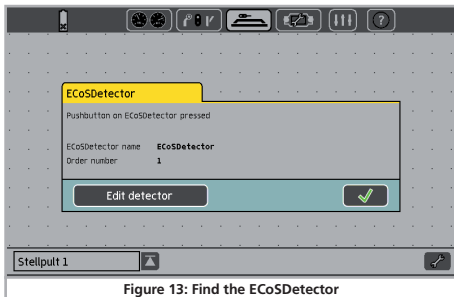

## 8.4. Administration of several ECoSDetectors

When your layout grows and you wish to use several ECoSDetector modules it may become necessary to change the indenture numbers at a later stage. We have developed a comfortable method for this.

- Press the tab “Administration” of any ECoSDetector in the configuration menu. A window similar to that in figure 14 will open.

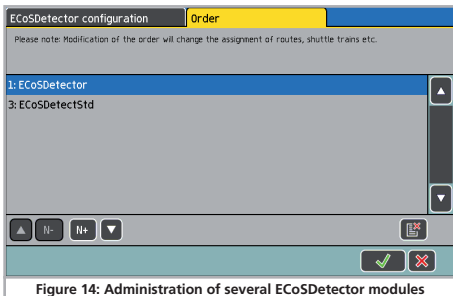

The list displays all detected ECoSDetector modules with their names and indenture numbers. The list is sorted by indenture number.

If you now wish to assign a new indenture number to an ECoSDetector simply mark the module concerned and press the button «N+» in order to increase the number or press «N-» in order to decrease the number.



Please make sure that all modules have different numbers.

## 9. Utilising feedback information

The feedback information provided by the ECoSDetector can be used exactly as described in chapter 15 of the ECoS manual. Of course, now the choice is not limited to s88 modules but also offers ECoSDetector feedback contacts.

### 9.1. Setting routes

If you wish to set a route you can now also select the ECoSDetector modules from the list of the feedback modules. Please note that the modules are sorted by increasing indenture number.

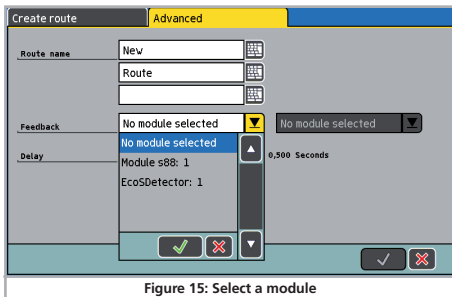

### 9.2. Track control diagram

You can display locomotive numbers read out with RailCom® on the track control diagram. For this purpose a new icon has been introduced in the setup of the track control diagram. After pressing the button shown on the left you can locate a display module that displays both the locomotive address and its name as soon as a valid address has been detected in this track sector.

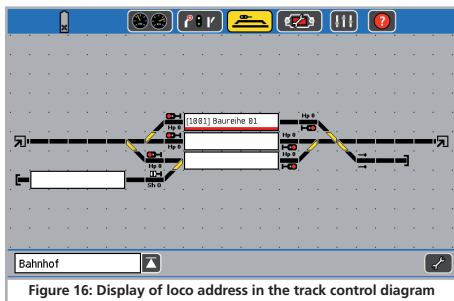

If you touch the display field either on the left or right side the locomotive is automatically assigned to the corresponding throttle of the ECoS and the display automatically changes to the train control mode

## 10. Technical data

### 10.1. Technical data ECoSDetector

Technical data ECoSDetector	
Operating modes	Direct bus connection to ECoSlink. Operation with ECoS or Central Station «Reloaded» possible.
Feedback	16 feedback inputs. Configurable via jumpers as digital inputs (e.g.: for track switches or reed contacts) or as occupancy detector (current guard). Galvanic separation of the feedback inputs from the command station. Maximum current 3A per feedback input.
RailCom®	4 of the 16 feedback inputs are configurable as RailCom feedback inputs («local detector»). Detection of the locomotive address.
Dimensions	86mm x 86mm x 25mm
Scope of delivery	feedback module, terminals, ECoSlink bus cable, detailed manual

### 10.2. Technical data ECoSDetector Standard

Technical data ECoSDetector Standard	
Operating modes	Direct bus connection to ECoSlink. Operation with ECoS or Central Station «Reloaded» possible.
Feedback	16 feedback inputs as digital inputs (e.g.: for track switches or reed contacts). Galvanic separation of the feedback inputs from the command station
Dimensions	86mm x 86mm x 25mm
Scope of delivery	ECoSDetector Standard feedback module, terminals, ECoSlink bus cable, detailed manual

## 11. Support and Assistance

Your model train dealer or hobby shop is your competent partner for all questions regarding your LokPilot decoder. In fact he is your competent partner for all questions around model trains.

There are many ways to get in touch with us. For enquiries please use either email, fax (please provide your fax-no. or email address) or go to **[www.esu.eu/en/forum](http://www.esu.eu/en/forum)** and we will reply within a few days.

Please call our hotline only in case of complex enquiries that can't be dealt with by email or fax. The hotline is often very busy and you may encounter delays. Rather send an email or fax and also check our website for more information. You will find many hints under "Support / FAQ" and even feedback from other users that may help you with your particular question.

Of course we will always assist you; please contact us at:

#### USA & Canada (English support), please contact:

Phone: +1 (570) 649-5048  
Tuesday & Thursday 9:00am - 3:00pm (CT)  
Fax: +1 (866) 591-6440  
Email: [support@loksound.com](mailto:support@loksound.com)  
Mail: ESU LLC  
477 Knopp Drive  
US-PA-17756 Muncy

#### Germany and all other countries, please contact:

Fax: ++49 (0) 731 - 1 84 78 - 299  
Email: [www.esu.eu/en/forum](http://www.esu.eu/en/forum)  
Mail: ESU GmbH & Co. KG  
- Technical support -  
Edisonallee 29  
D-89231 Neu-Ulm  
**[www.esu.eu](http://www.esu.eu)**

## 12. Warranty Certificate

### **24 Months warranty form date of purchase**

Dear customer,

Congratulations on purchasing this ESU product. This quality product was manufactured applying the most advanced production methods and processes and was subject to stringent quality checks and tests.

Therefore ESU electronic solutions ulm GmbH & Co. KG grants you a warranty for the purchase of ESU products that far exceeds the national warranty as governed by legislation in your country and beyond the warranty from your authorised ESU dealer.

### **ESU grants an extended manufacturer's warranty of 24 months from date of purchase.**

#### Warranty conditions:

- This warranty is valid for all ESU products that have been purchased from an authorised ESU dealer.
- Any service, repair or replacement under this warranty requires proof of purchase. The filled in warranty certificate together with the receipt from your ESU dealer serves as proof of purchase. We recommend keeping the warranty certificate together with the receipt.
- In case of a claim please fill in the enclosed failure report card as detailed and precise as possible and return it with your faulty product.
- Please use the appropriate postage when shipping to ESU.

#### Extent of warranty / exclusions:

This warranty covers the repair or replacement free of charge at the discretion of ESU electronic solutions ulm GmbH & Co. KG of any faulty parts that are caused by design faults or faults in production, material or transport. Any further claims are explicitly excluded.

#### The warranty expires:

1. In case of wear and tear due to normal use.
2. In case of conversions of ESU – products with parts not approved by the manufacturer.
3. In case of modification of parts.
4. In case of inappropriate use (different to the intended use as specified by the manufacturer).
5. If the instructions as laid down in the user manual by ESU electronic solutions ulm GmbH & Co. KG were not adhered to.

There is no extension of the warranty period due to any repairs carried out by ESU or re-placements.

You may submit your warranty claim either with your dealer or by shipping the product in question with the warranty certificate, the receipt of purchase and the fault description directly to ESU electronic solutions ulm GmbH & Co. KG at:

ESU GmbH & Co. KG  
- Service department -  
Edisonallee 29  
D-89231 Neu-Ulm  
GERMANY

# Trouble shooting sheet

## 1. Customer data

(Please write in block letters)

Name: .....  
Street: .....  
ZIP/City: ..... | | | | |  
Country: .....  
Email: .....  
Phone: .....  
Date: .....  
Signature: .....

## 2. Error class

- Is not detected by the command station (LED flashes)       No feedback information  
 No function (error cannot be exactly determined)       No RailCom® address information

## 3. Error description (use extra page, if needed)

.....  
.....  
.....  
.....  
.....

## 4. Receipt / Proof of purchase

Please enclose your receipt / invoice. Otherwise no warranty possible!

## 5. Additional information:

.....  
.....  
.....  
.....  
.....

## 6. Your retailer:

.....  
.....  
.....  
.....  
.....

Retailer's stamp or address

