



IM KLEINEN GROSS

# DAS BASIC-PRINZIP

Gestalten, falten, stecken – fertig!

Shape, fold, assemble – done! • Former, plier, emboîter – c'est terminé !

Tekenen, vouwen, in elkaar steken – klaar! • Decora, piegare, assembla – fatto!

Diseñar, plegar, insertar – ¡y listo!



# FALLER BASIC



Kein Werkzeug benötigt!  
No tools needed!  
Aucun outil nécessaire!  
Geen gereedschap nodig!  
Non servono utensili!  
¡Sin necesidad de herramientas!

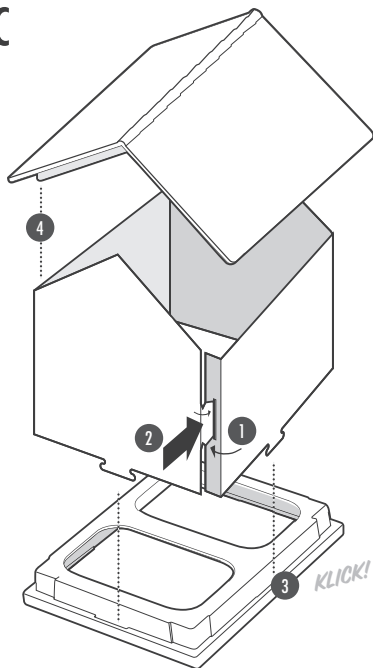

**DEUTSCH** ① Pappwände/-abwicklung falten ② Wände an der Lasche zusammenstecken ③ Wände mit dem Boden verbinden ④ Dach aufsetzen ⑤ Anbauwände mit 2. Boden zusammenstecken ⑥ 2. Dach aufsetzen ⑦ Anbau und Hauptgebäude verbinden

**ENGLISH** ① Fold cardboard walls ② Click walls together at lug ③ Connect walls to the base ④ Put roof on top ⑤ Connect annex walls to second base ⑥ Put second roof on top ⑦ Connect annex and main building

**FRANÇAIS** ① Plier les parois/la réalisation en carton ② Emboîter les parois sur la languette ③ Assembler les parois avec le sol ④ Positionner le toit ⑤ Emboîter les parois de l'annexe avec le 2<sup>e</sup> sol ⑥ Positionner le 2<sup>e</sup> toit ⑦ Assembler l'annexe et le bâtiment principal

**NEDERLANDS** ① Kartonnen muren vouwen ② Muren met het lipje aaneen bevestigen ③ Muren met de bodem verbinden ④ Dak opzetten ⑤ Muren van bijgebouw in 2e bodem plaatsen ⑥ 2e dak opzetten ⑦ Bijgebouw met hoofdbouw verbinden

**ITALIANO** ① Piegate le pareti di cartone lungo le linee fustellate ② Congiungere le pareti mediante la linguetta ③ Unire le pareti al pavimento ④ Applicare il tetto ⑤ Congiungere le pareti dell'edificio annesso con il secondo pavimento ⑥ Applicare il secondo tetto ⑦ Unire la costruzione annessa all'edificio principale

**ESPAÑOL** ① Plegar las paredes y elevaciones internas del cartón ② Juntar las paredes por la pieza de unión ③ Unir las paredes con el suelo ④ Colocar el tejado ⑤ Juntar las paredes del anexo con el 2.º suelo ⑥ Colocar el 2.º tejado ⑦ Unir el anexo y el edificio principal

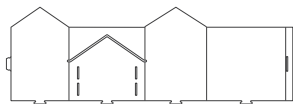

1 - 4

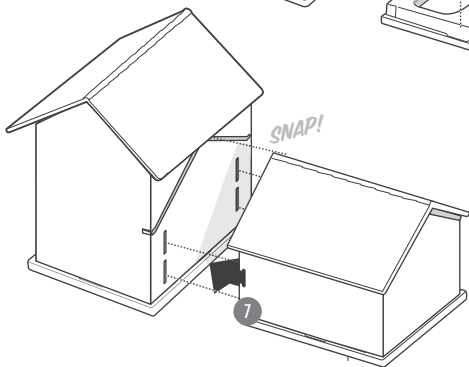
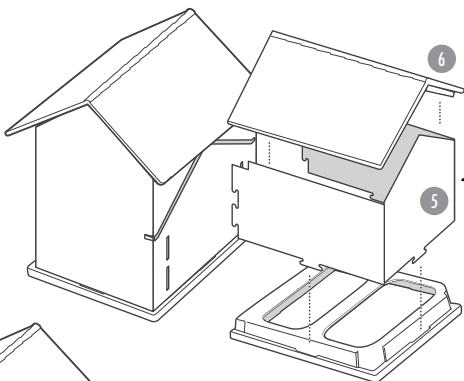

5 - 7 Nicht bei allen Modellen!  
Not for all models!  
Pas pour tous les modèles !  
Niet bij alle modellen!  
Non in tutti i modelli!  
¡no en todos los modelos!

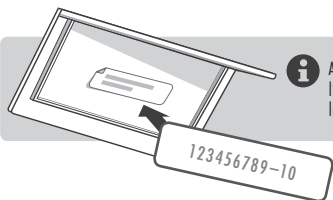

Adresse/Kontakt einkleben / Stick on address/contact / Coller l'adresse/le contact / Adres/contactgegevens inplakken / Incollare l'indirizzo o il contatto / Pegar dirección/contacto



150110

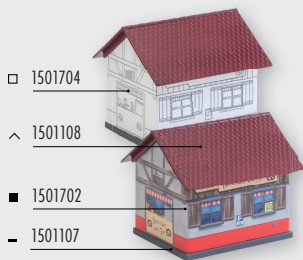

150170

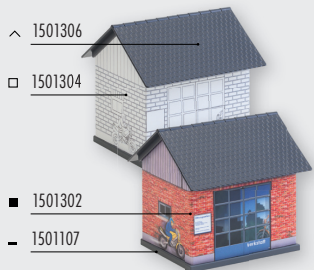

150130

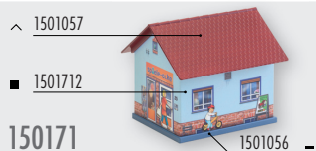

150171

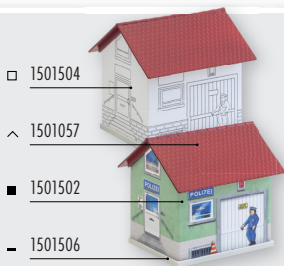

150150

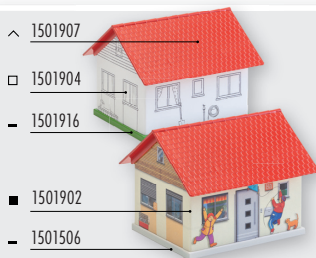

150190/150191

- ^ Dach/Roof/Toit/Dak/Tetto/Tejado
- Wände bedrukt/Printed walls/Pareis imprimées  
Muren met print/Pareti stampate/Paredes impresas
- Bemalwände/Plain walls/Murs à peindre  
Muren om op te tekenen/Pareti da dipingere  
Paredes para pintar
- Boden/Base/Sol/Bodem/Pavimento/Suelo