

Kibri® 16303 A

Unimog Euro II kurz mit Schwemmeinrichtung

Unimog Euro II with digger grab (road/rail)
Unimog Euro II court pour pulvérisation route-rail

Unimog mit Euro II Fahrerhaus
6 Zylinder Reihendieselmotor
177 kW / 240 PS, Klimaanlage
Arbeitsbreite 2,40m
Pumpenleistung 75 bar
Arbeitsgeschwindigkeit 6 km/h
bis 10.000m²/h je nach Verschmutzung
Wassermenge 1.000 - 3.000 Liter

Dieser Bausatz wurde sorgfältig geprüft. Sollte dennoch ein Teil fehlen oder fehlerhaft sein, dann fordern Sie dieses bitte unter Angabe der Bausatz-, Spritzling- und Teilenummer, die aus der Bauanleitung hervorgehen, bei uns an. Um Übermittlungsfehler auszuschließen, können wir Ersatzteilanforderungen nur noch schriftlich entgegennehmen!

The contents of this kit have been carefully checked and thus should correspond with components as listed in the „Parts List“. Nevertheless, and in the event that a part / component is missing or is faulty, please request the necessary part, stating article, shot and part number as listed on the instruction sheet.

Cet article a été contrôlé avec soin. Si, malgré nos précautions, une pièce manquant ou était défectueuse, veuillez nous la demander en précisant la référence de la maquette et le numéro de grappes et le numéro de la pièce, indiqués sur la notice de montage.

Änderungen vorbehalten
Sous réserve de modifications

Subject to alterations
Made in Germany

Kibri® - Spielwarenfabrik GmbH
Postfach 1540 · D-71005 Böblingen

www.kibri.com / info@kibri.com

Inhalt - contents - contenu
Hart Et.: 389

Nr.	Stück	Nr.	Stück
411	1	1878	2
1346	1	1895	1
1347 B+C	1	1896	1
1349	1	1897	1
1350	1	1900	1
1350/1	1	1901	1
1392	1	1906	1
1393	1	1951	2
1559	1	2069	1
1863	1	2070	1

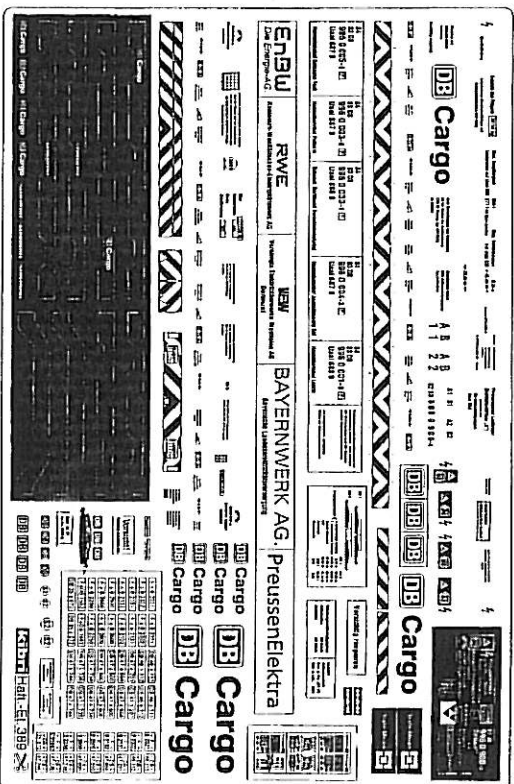

Bitte beachten!
Beim Zusammenbau die Reihenfolge der Bauabschnitte einhalten! Benötigtes Teil mit einem Seitenschneider bzw. Modellbaummesser vom Spritzbaum abtrennen und entfernen. Vorsicht Verletzungsgefahr!
Kleben nur mit Kibri-Plastikleber Nr. 9995.
Anderer Klebstoffe können zu Verformungen der Kunststoffteile führen.
Da Spritzlinge für mehrere Artikel verwendet werden, kann es sein, dass bei diesem Bausatz einige Teile übrig bleiben.

Please note!
When building this kit, please keep to the sequence of construction step as shown. Individual pieces should be separated from the sprue using cutters or a hobby knife, removing any flash at the same time, talking care not to injure yourself when doing so.
Use only Kibri plastic adhesive No. 9995.
Other adhesives may deform the plastic pieces!
As each sprue may be used in several different kits, it may well be that some pieces will not be required for this kit.

Attention!
Veillez à bien respecter l'ordre d'assemblage des pièces! Détachez les pièces nécessaires du jet et lissez convenablement la découpe au moyen d'un stanley. Attention de ne pas vous couper!
Ne coller qu'avec la colle plastique Kibri N° 9995.
L'utilisation d'autres colles peut entraîner une déformation des pièces synthétiques!
Étant donné que certains jets sont utilisés pour plusieurs articles, il est possible que cette boîte de construction contienne quelques pièces excédentaires.

Weitere Informationen über das gesamte Kibri-Sortiment finden Sie im Kibri-Katalog, den Sie entweder in Ihrem Fachgeschäft oder direkt bei Kibri gegen eine Schutzgebühr beziehen können.

Further information regarding the whole Kibri range can be found in the Kibri-catalogue which is obtainable from your specialist dealer or directly from Kibri for a small charge.

Pour plus d'informations concernant de l'assortiment Kibri, consultez le catalogue Kibri, que vous pouvez obtenir chez votre détaillant ou directement chez Kibri, moyennant paiement.

16303 B

411

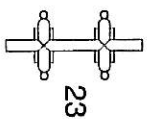

1346

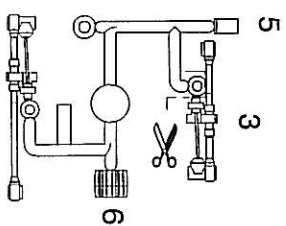

1347B+C

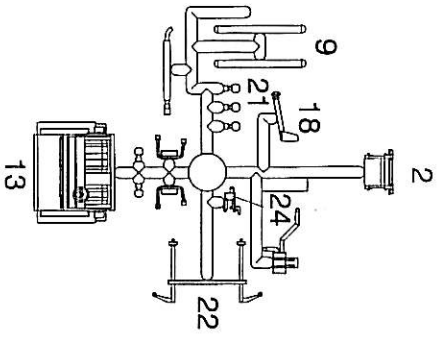

1349

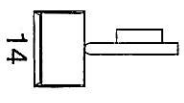

1350/1

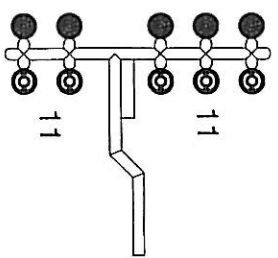

1350

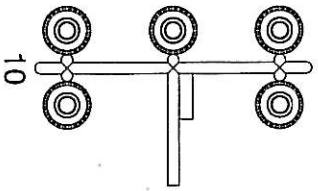

1392

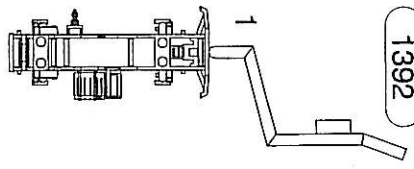

1393

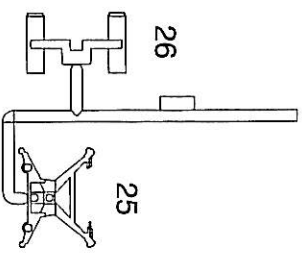

411

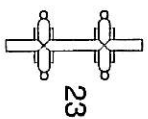

1346

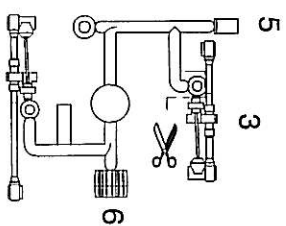

1347B+C

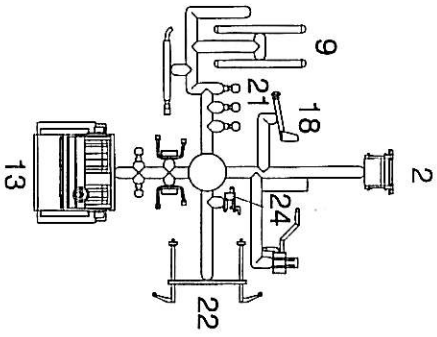

1349

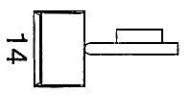

1350/1

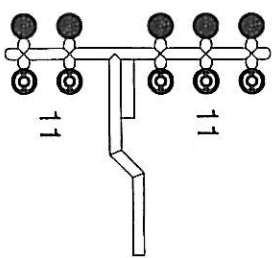

1350

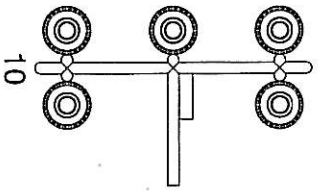

1392

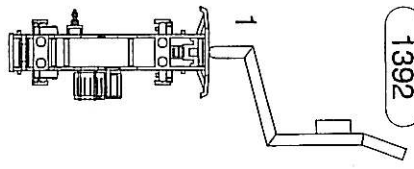

1393

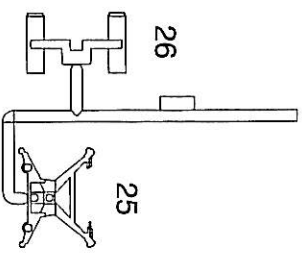

1559

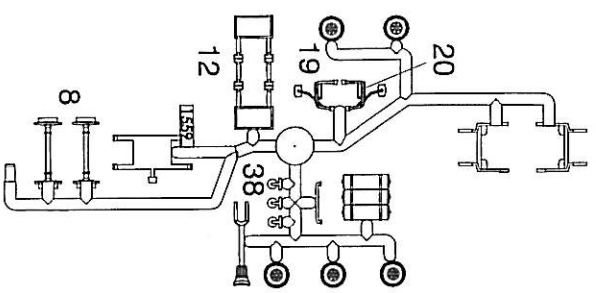

1863

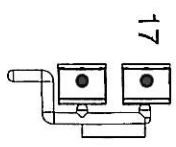

1896

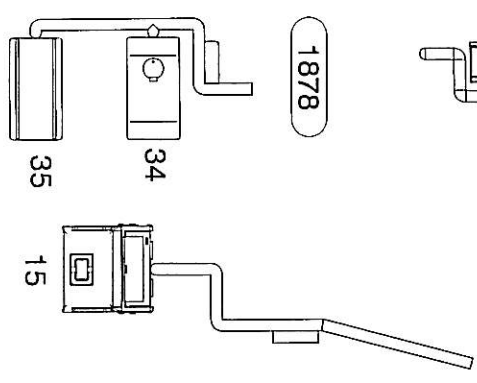

1897

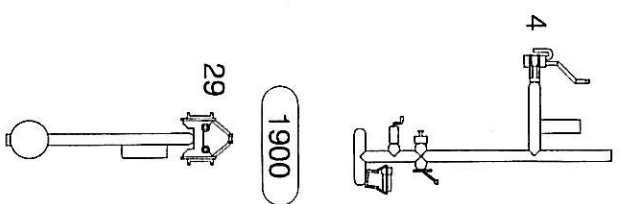

1901

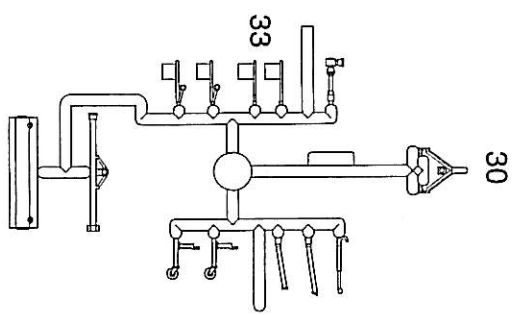

1906

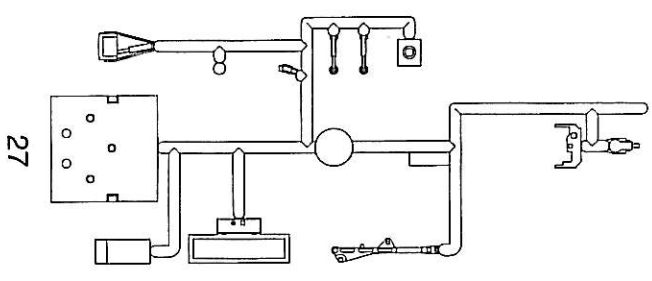

2069

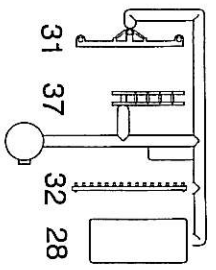

2070

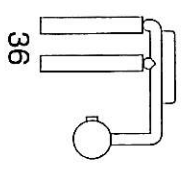

1878

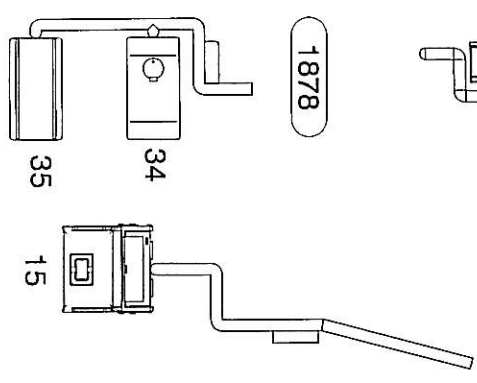

1900

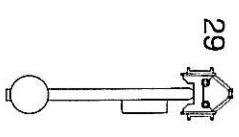

1951



1895

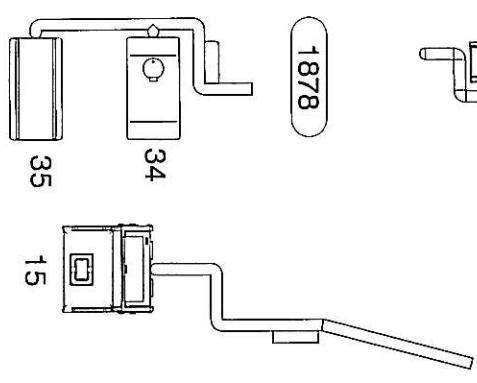
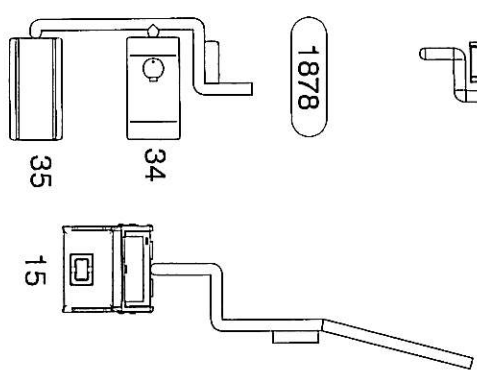
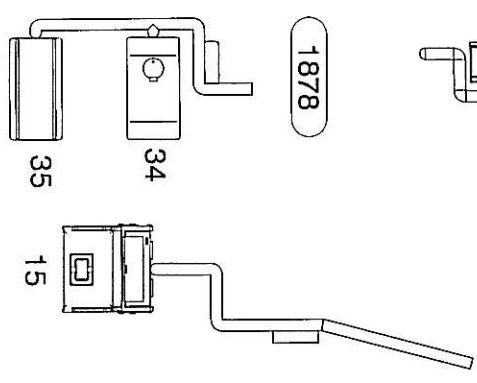
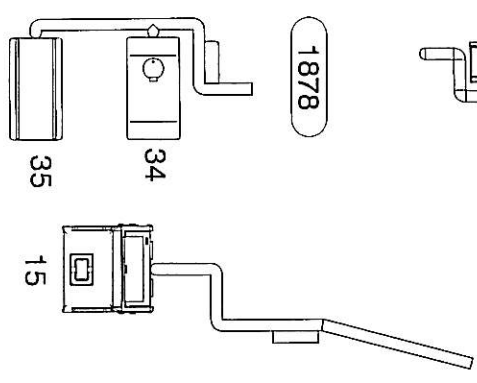
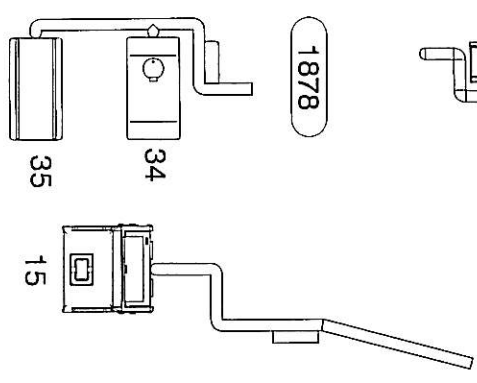
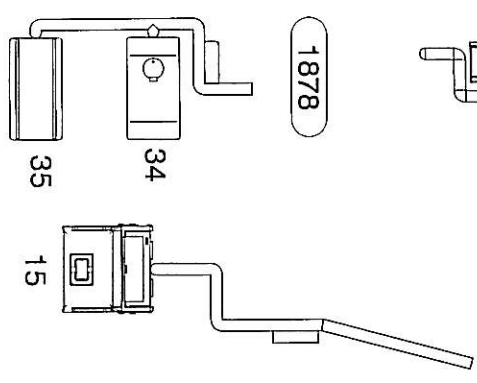
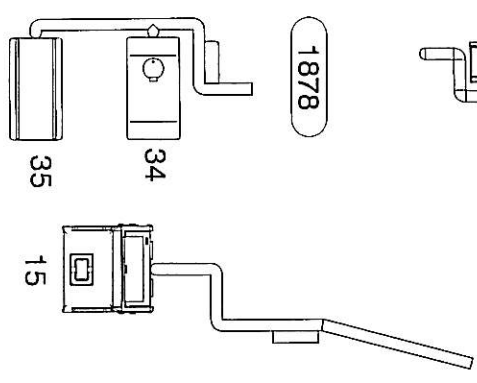
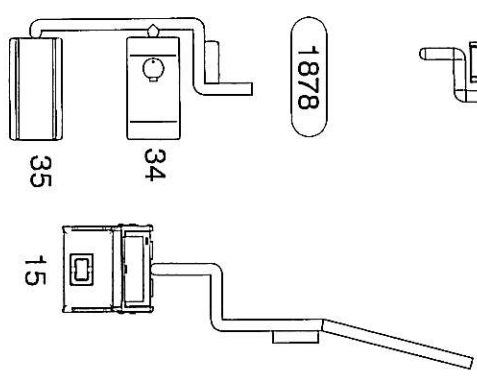
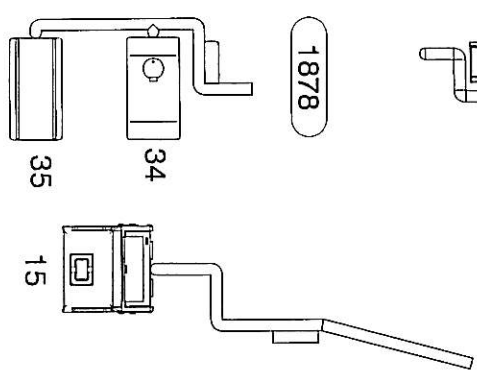
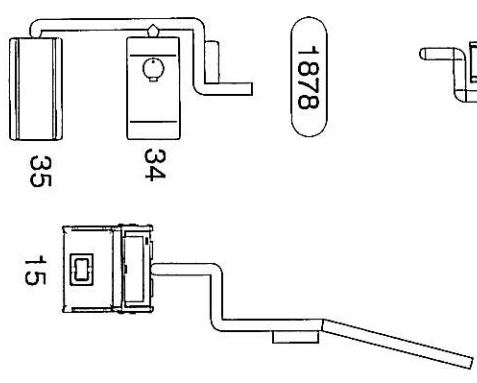
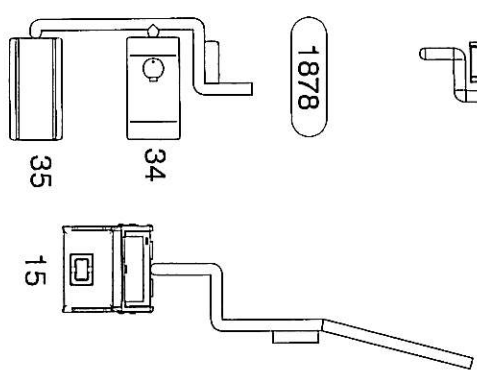
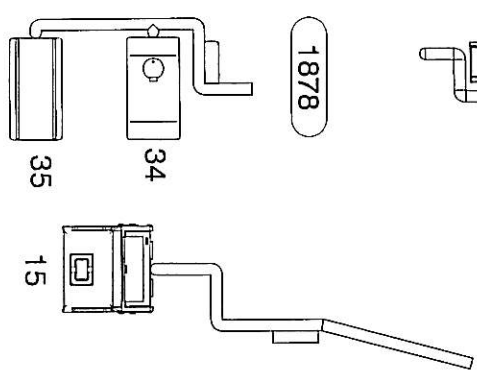
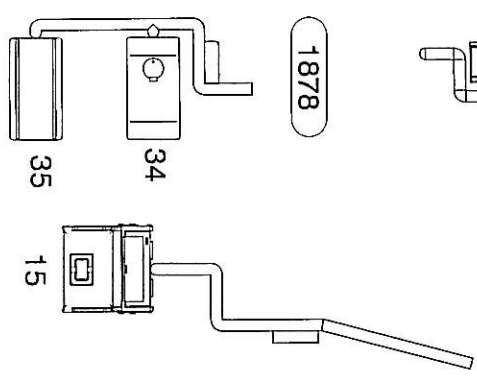
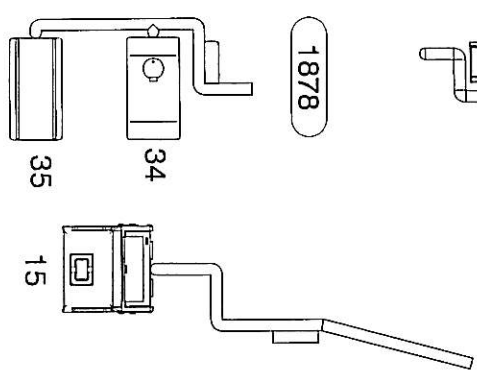
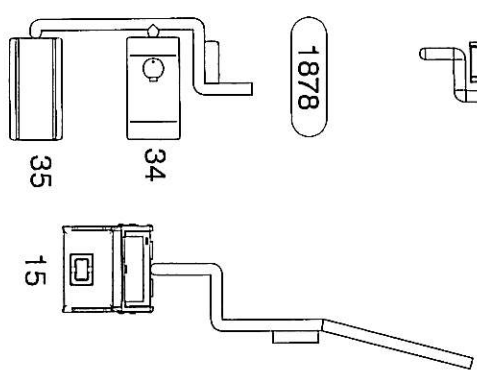
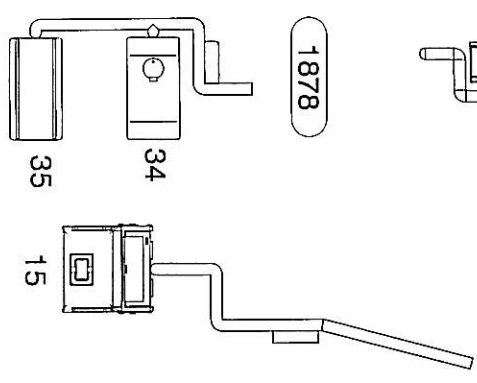
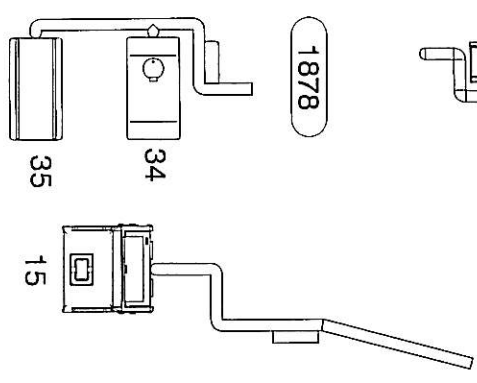
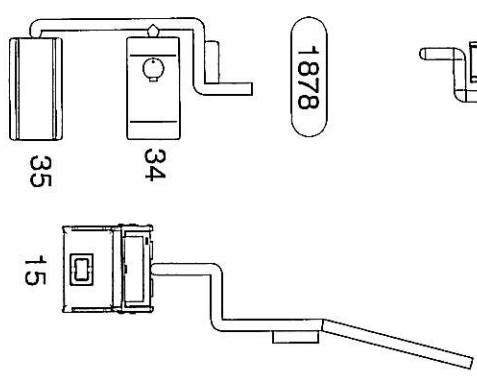
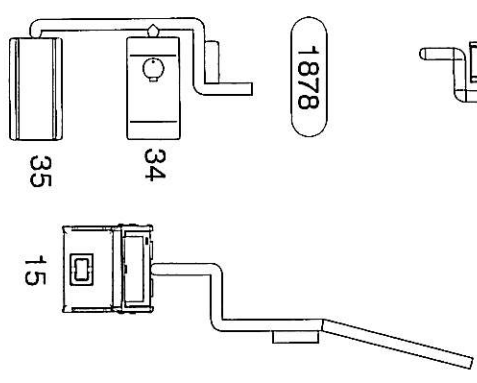
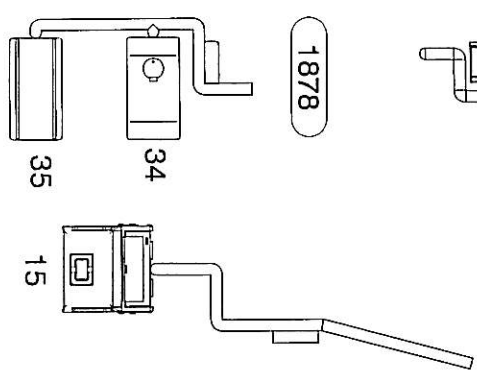
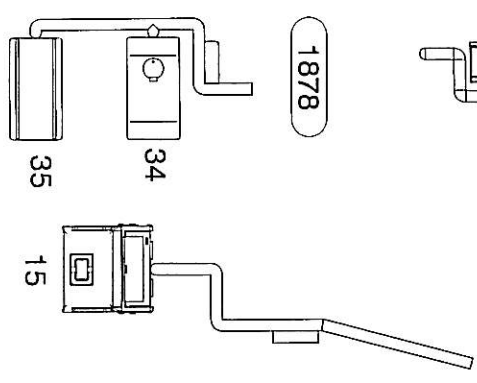
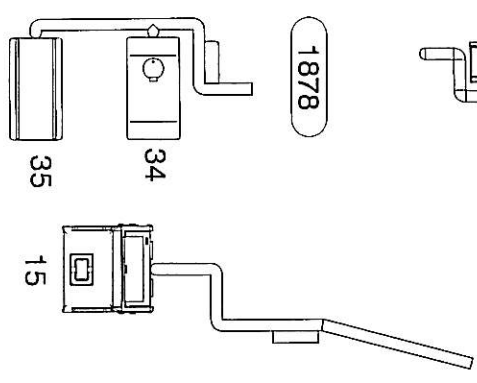
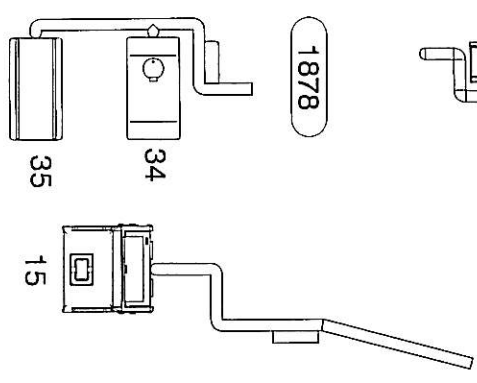
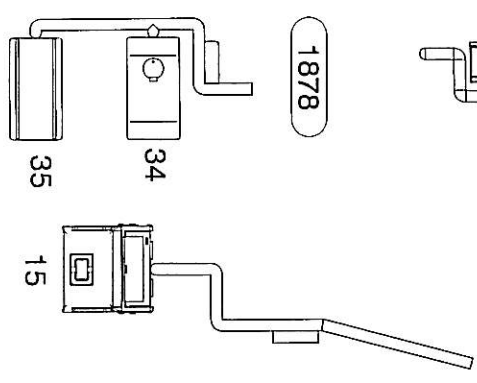
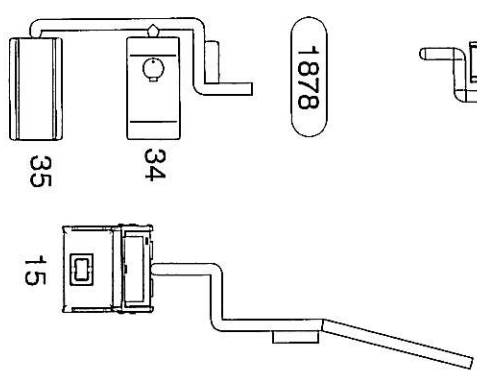
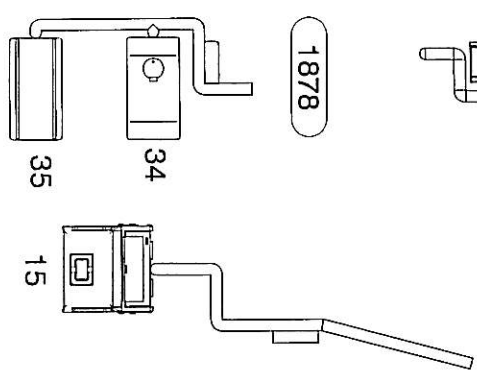
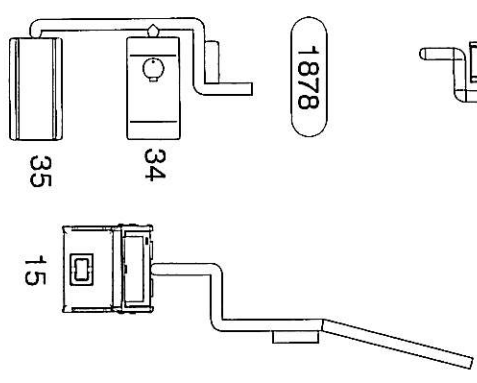
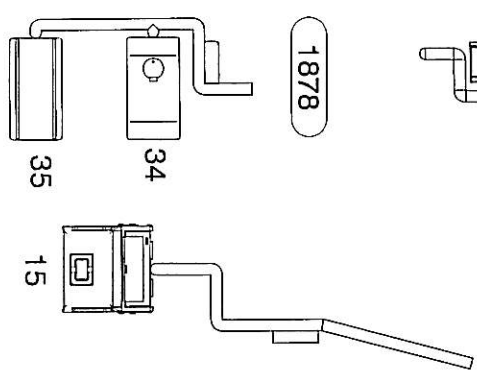
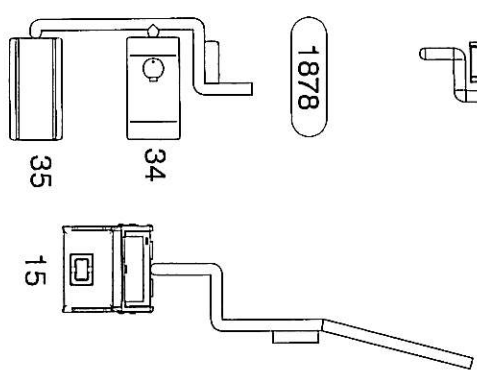
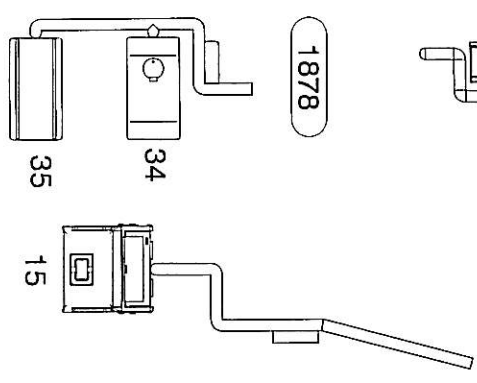
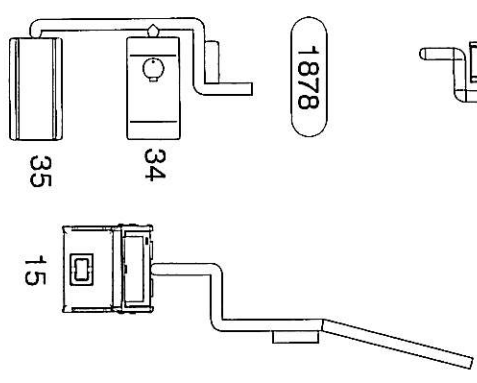
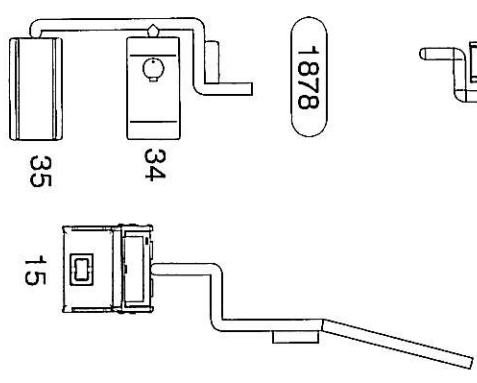
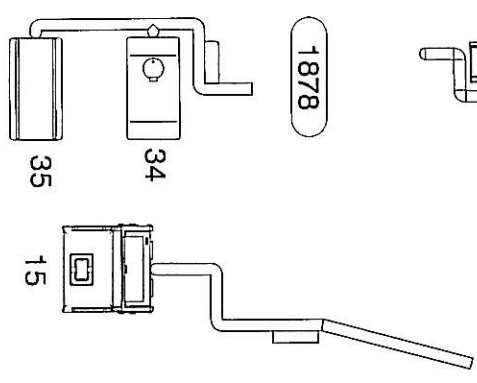
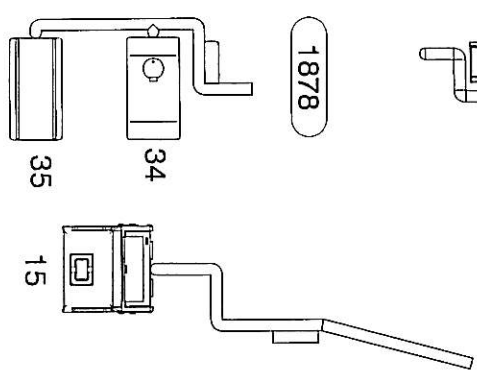
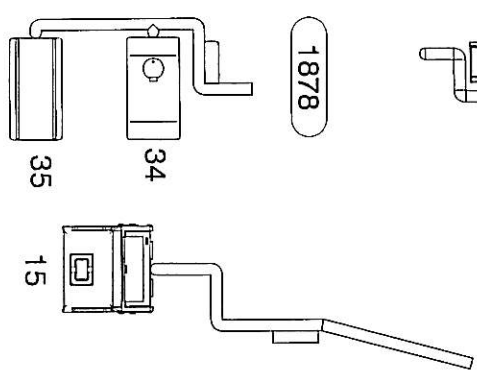
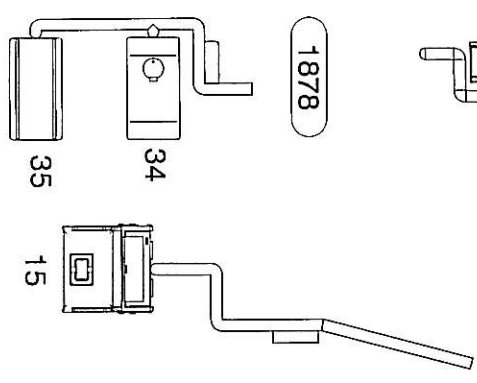
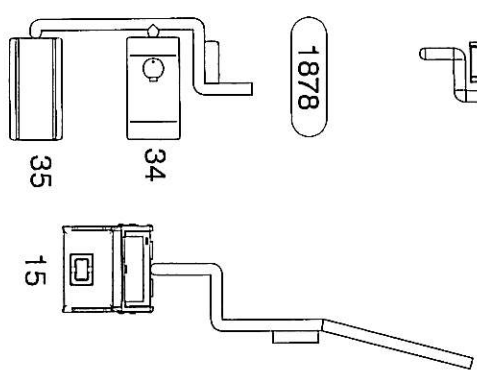
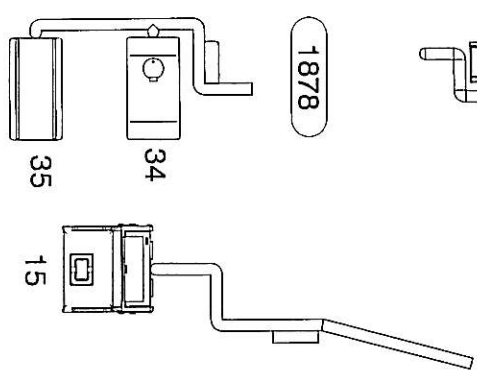
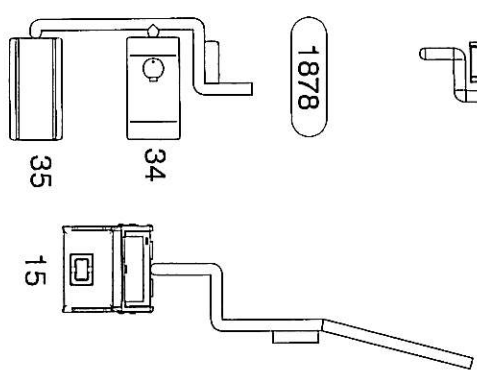
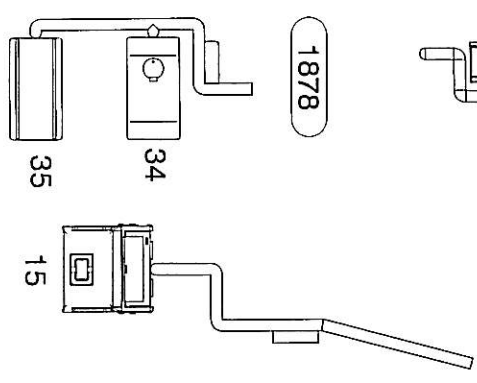
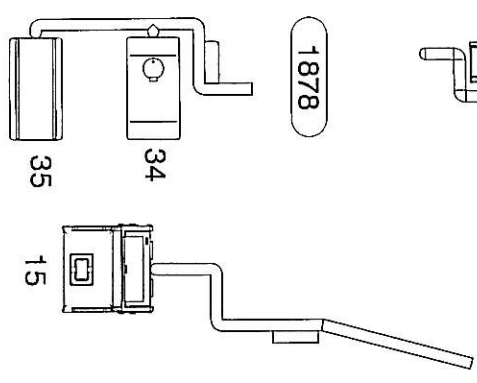
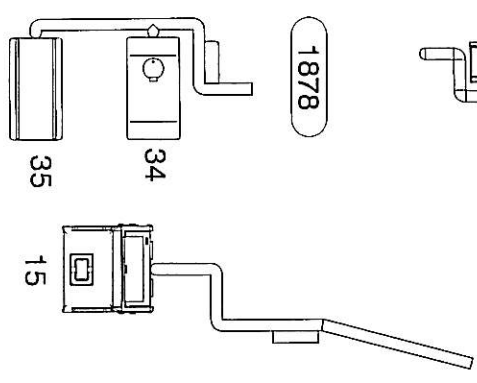
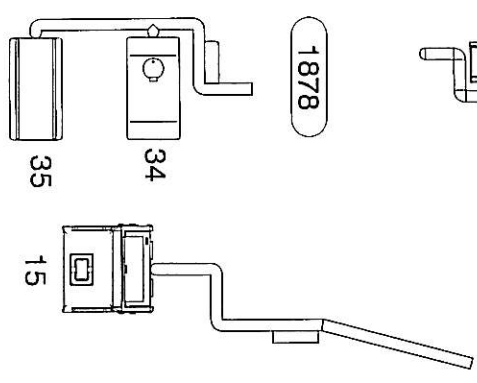
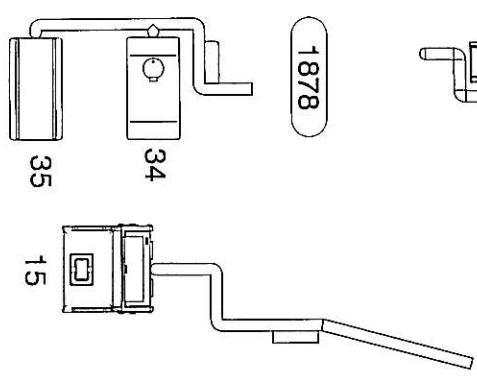
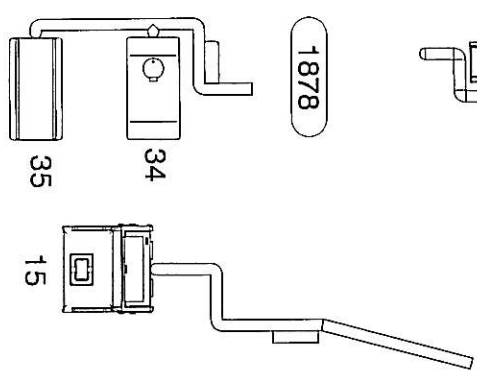
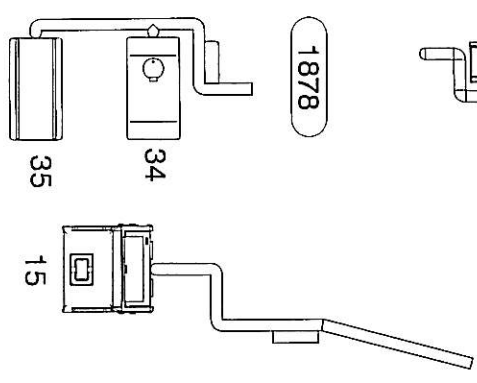
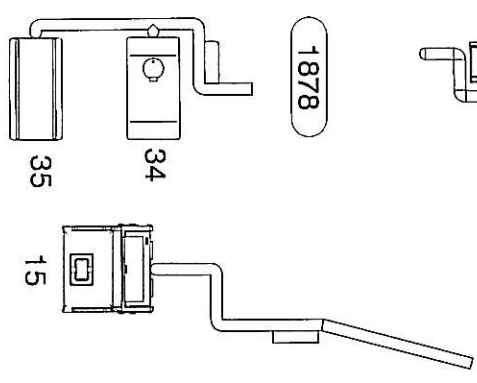
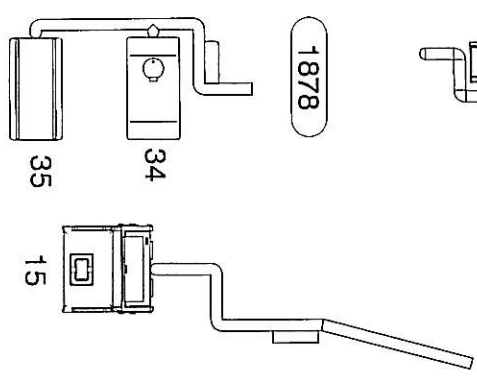
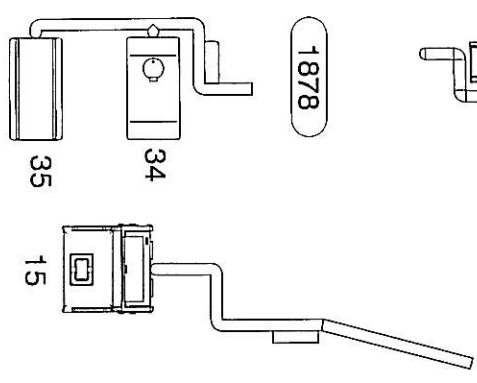
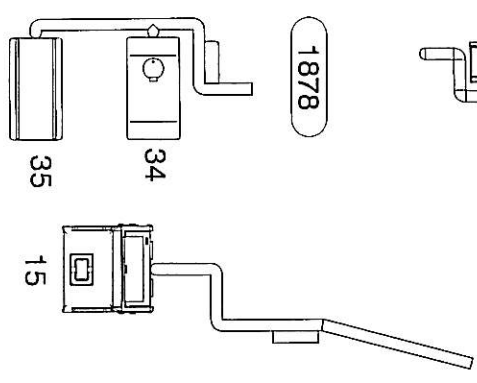
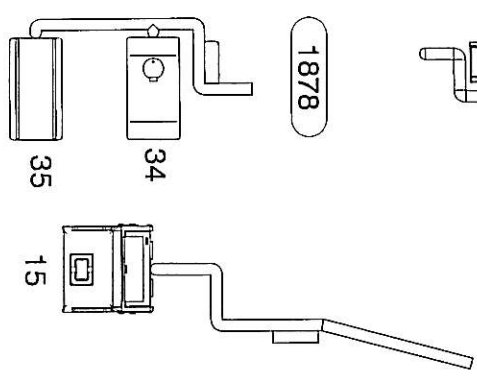
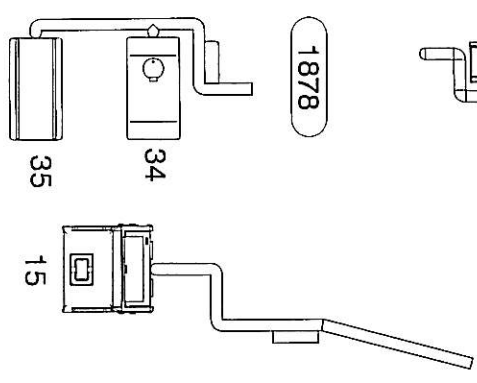
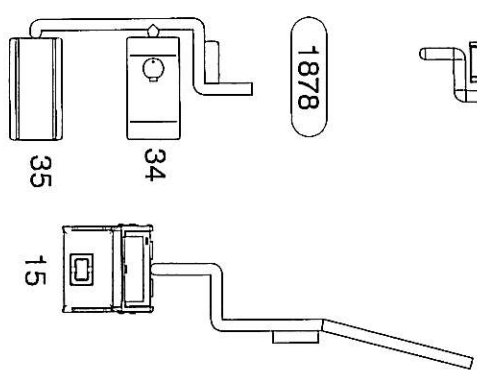
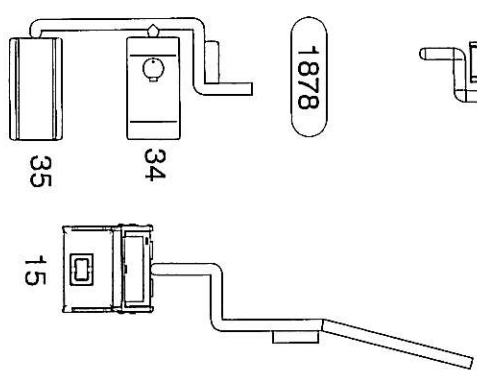
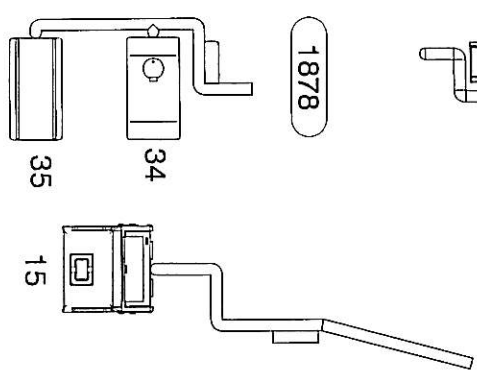
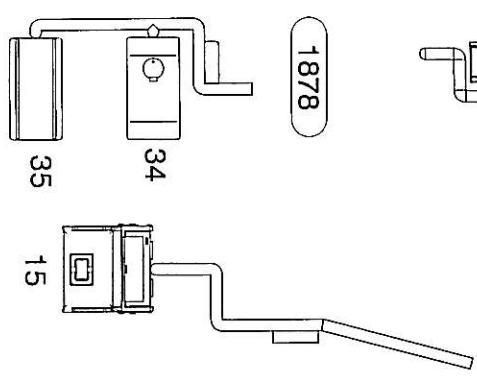
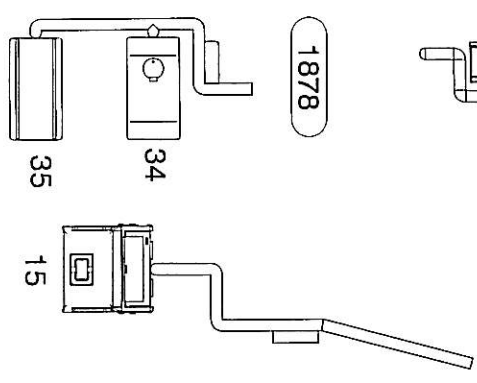
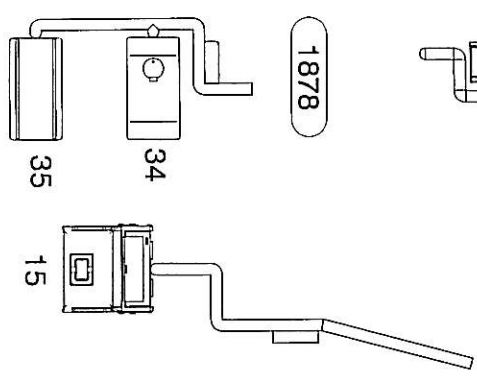
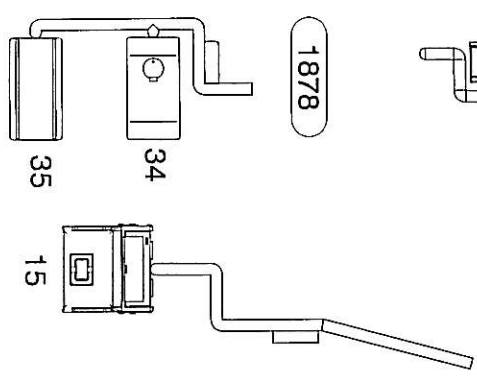
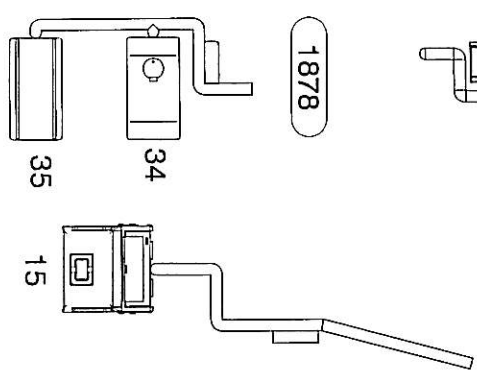
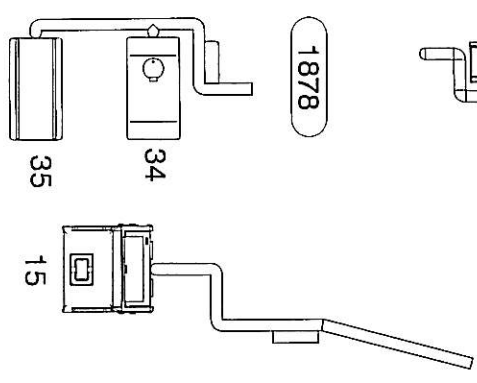
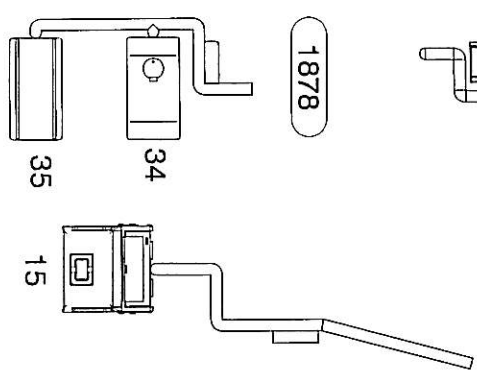
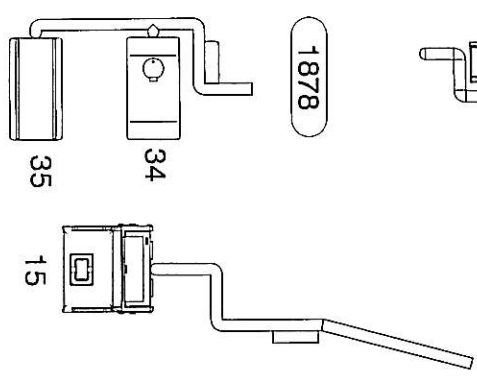
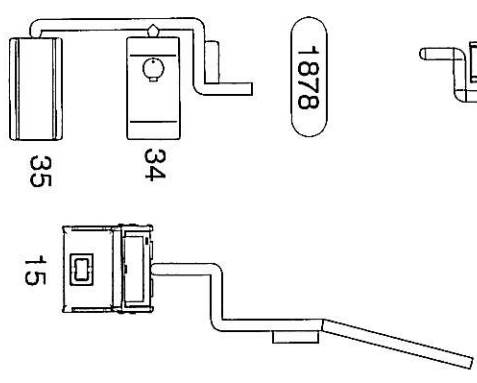
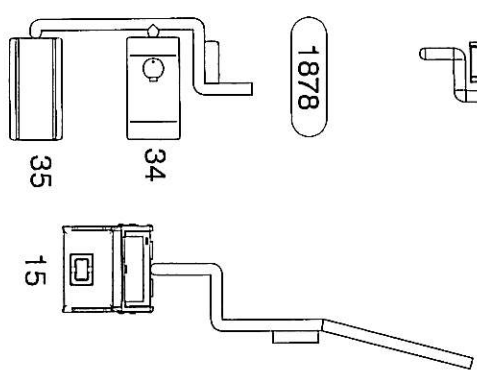
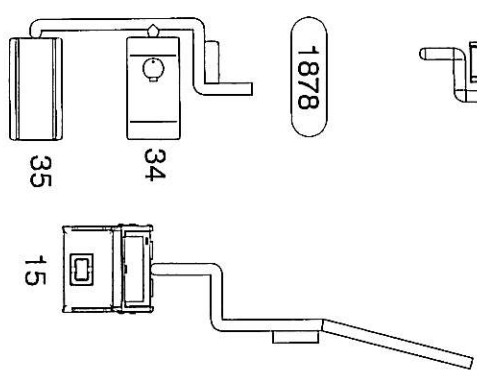
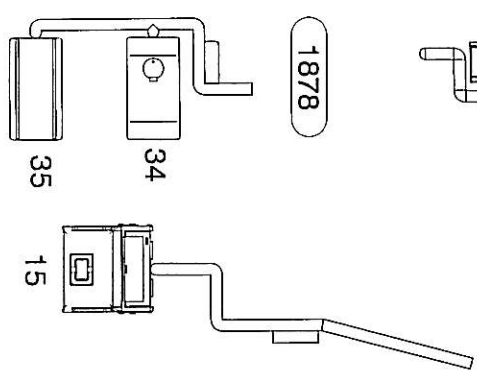
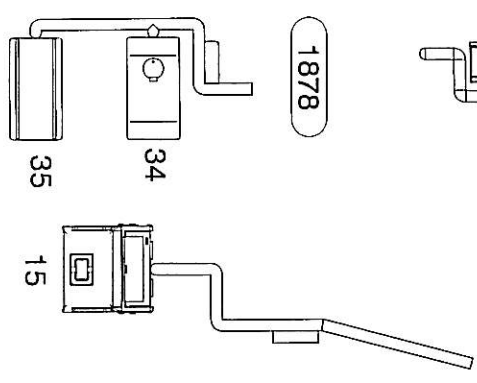
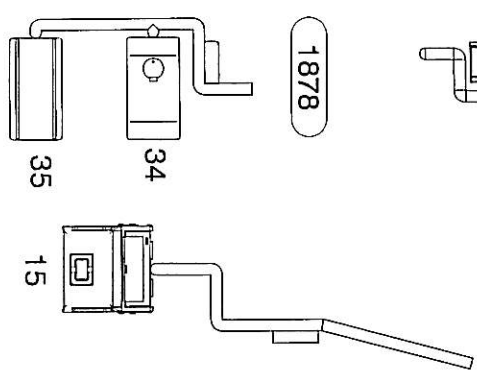
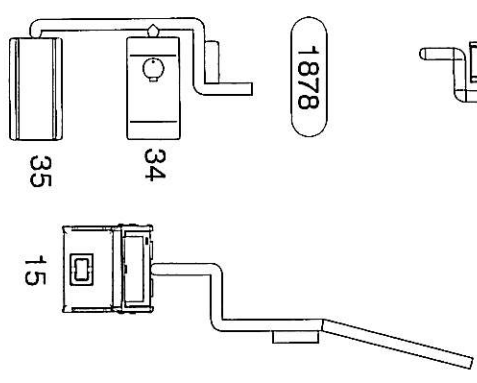
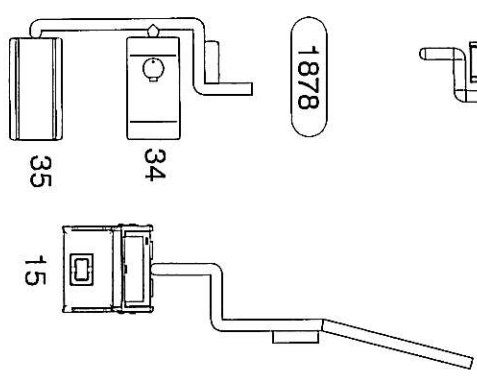
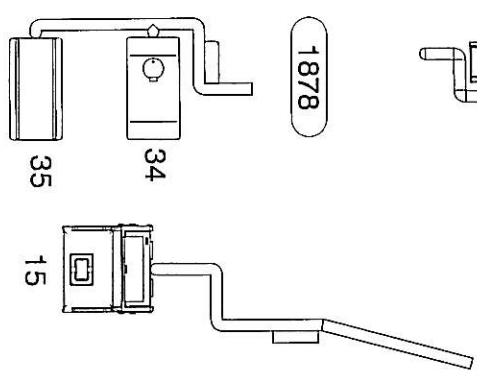
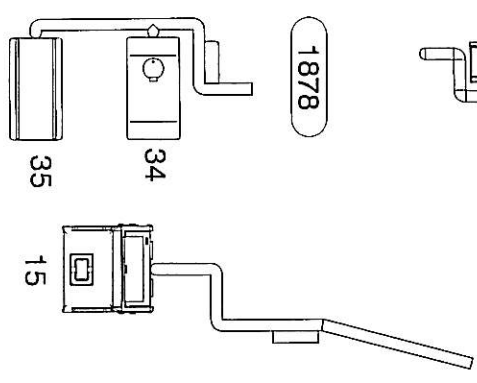
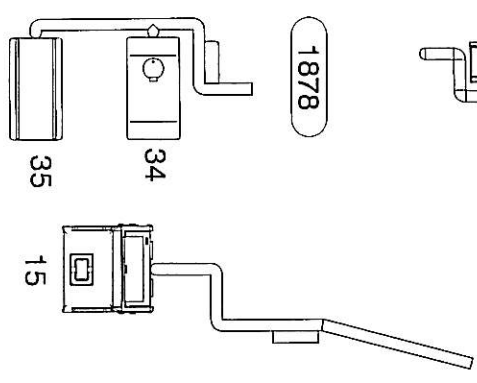
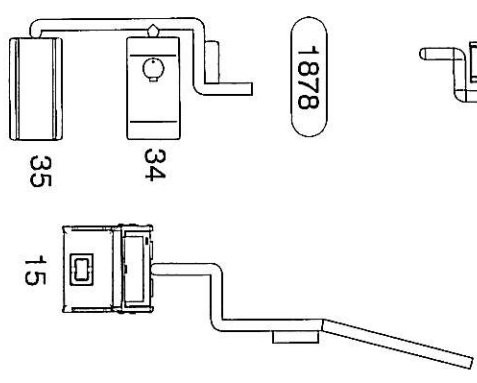
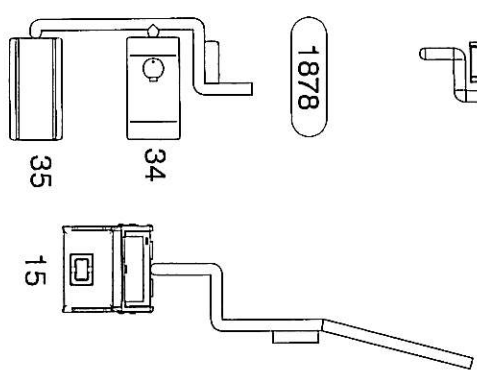
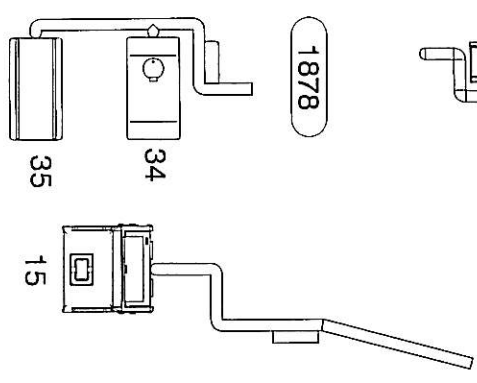
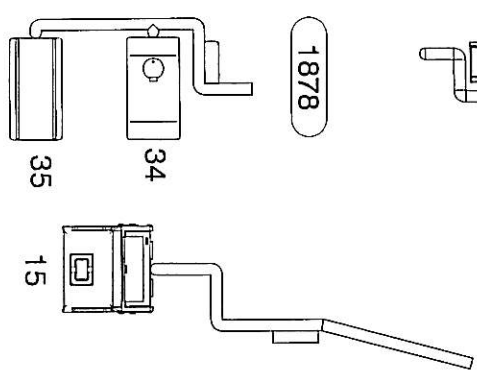
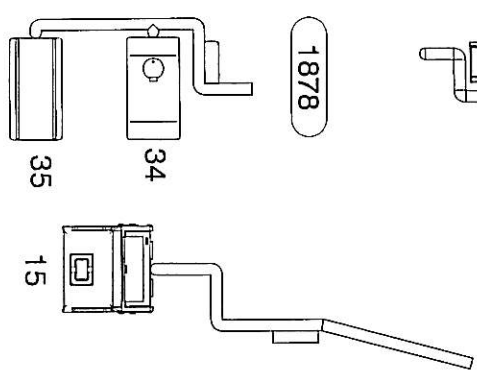
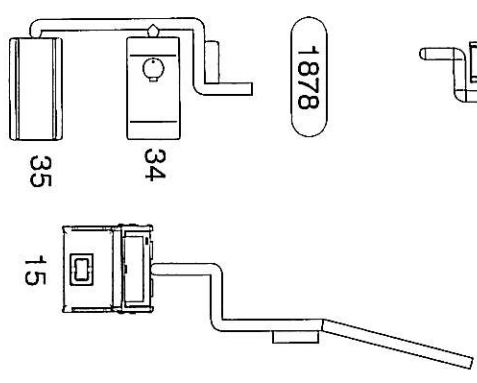
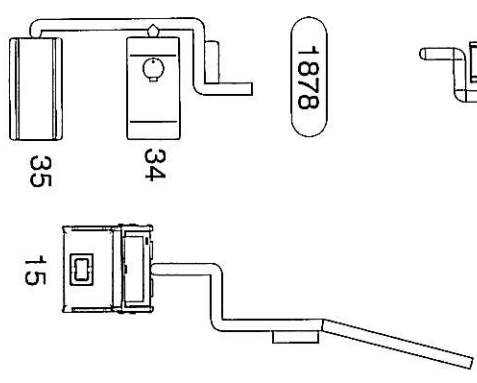
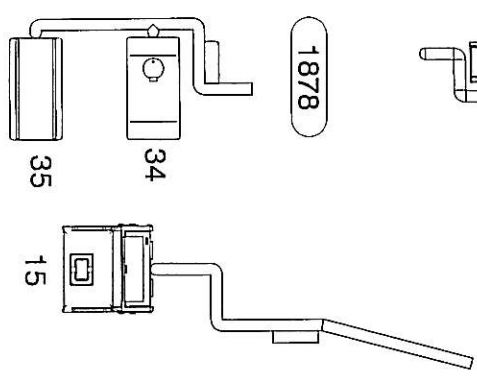
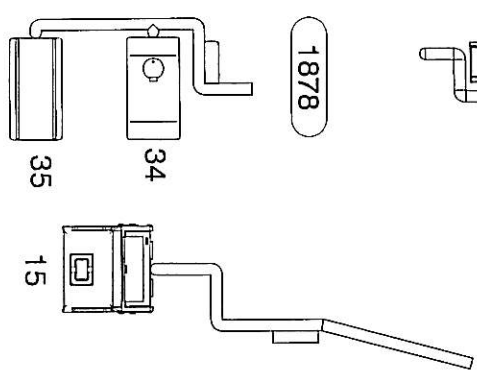
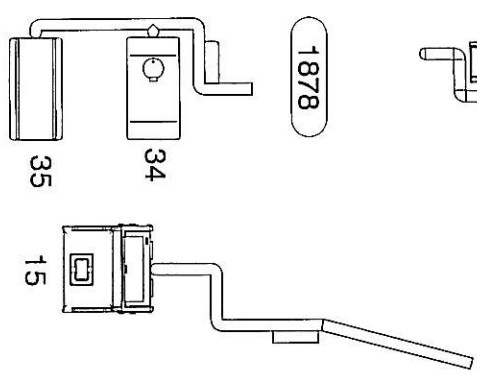
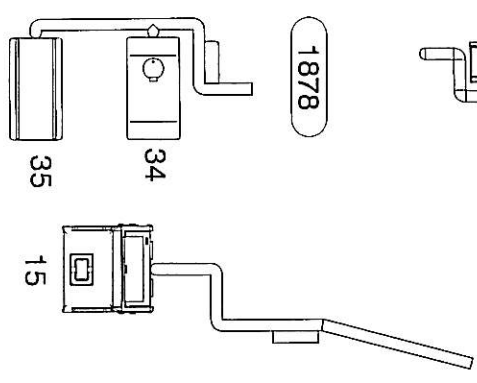
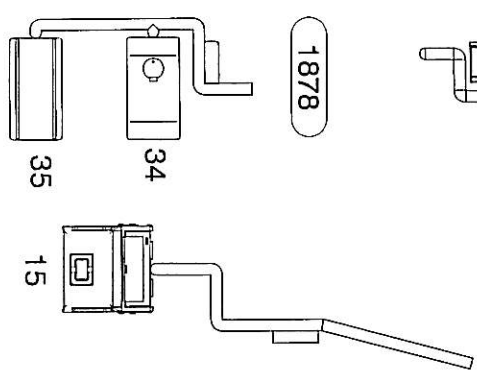
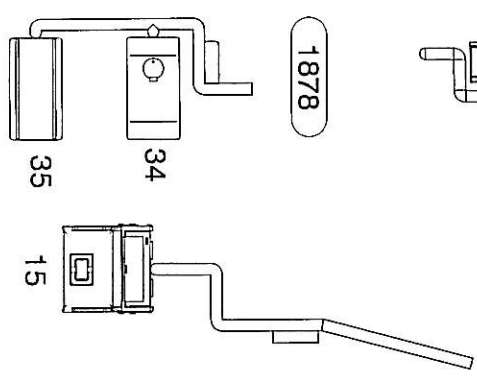
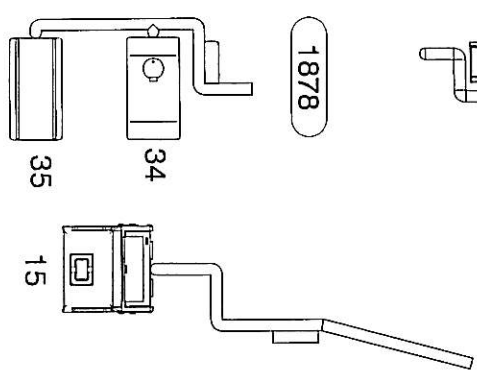
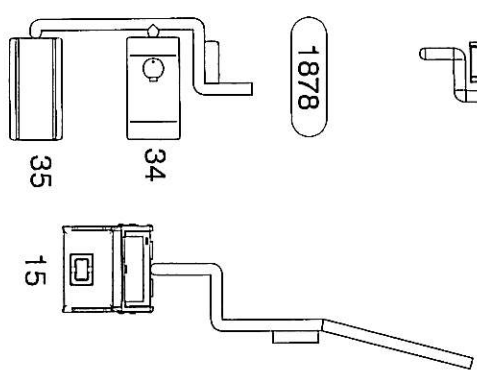
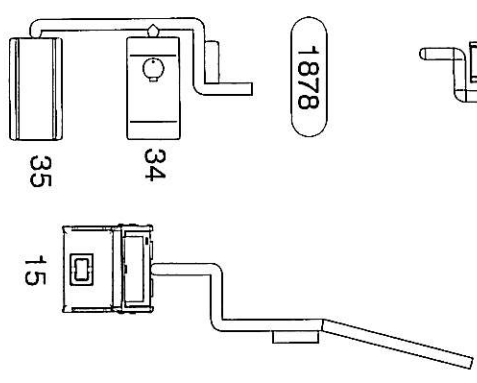
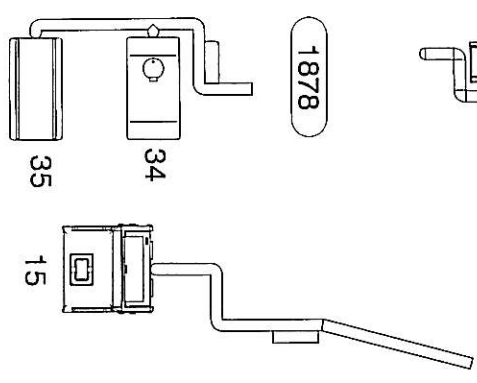
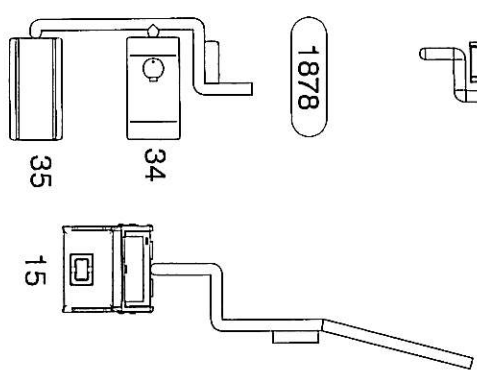
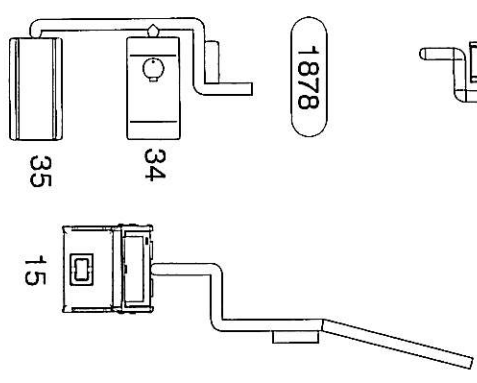
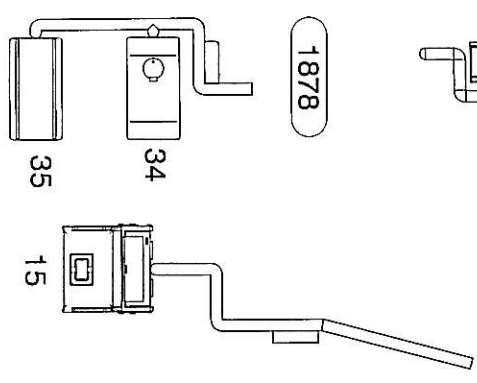
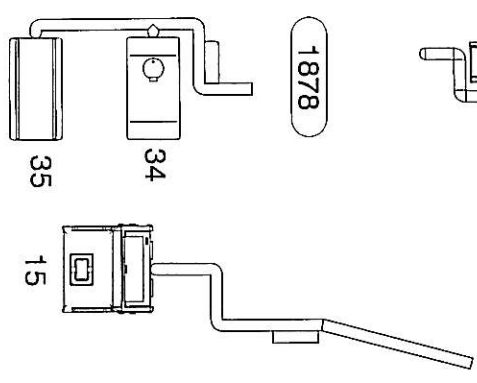
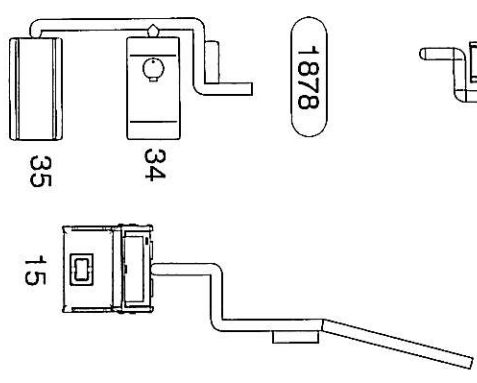
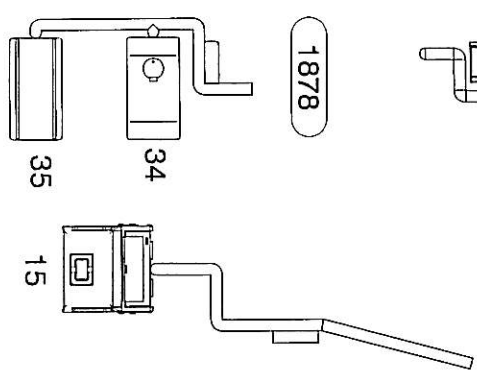
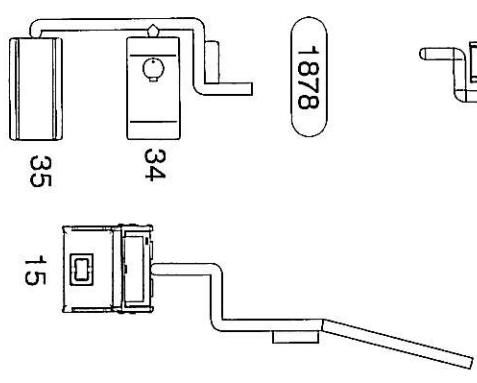
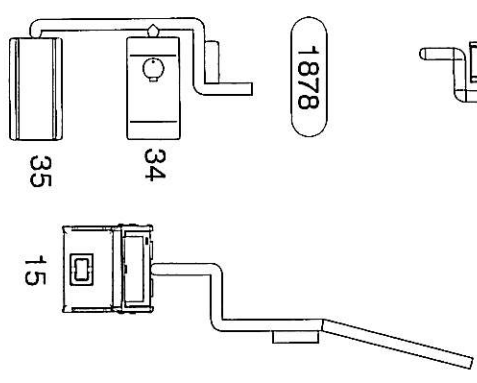
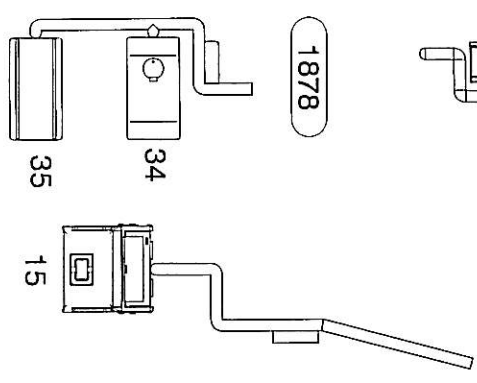
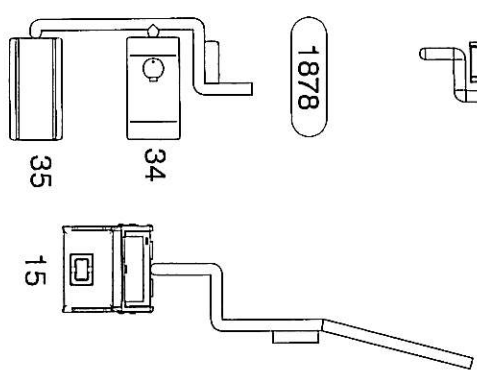
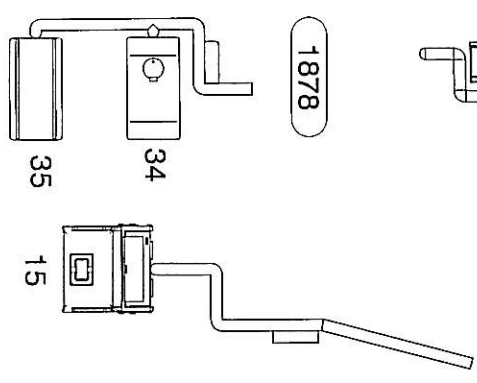
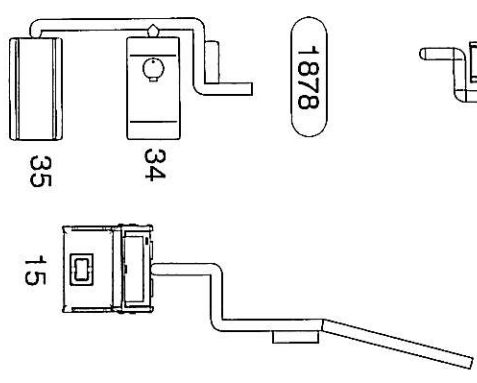
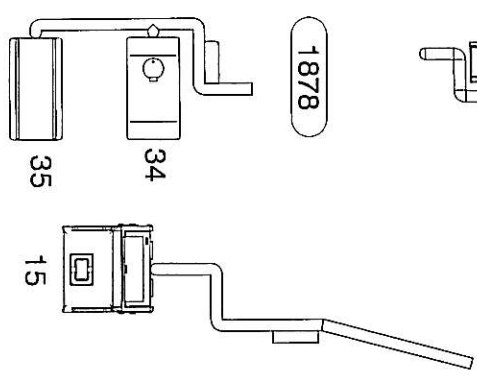
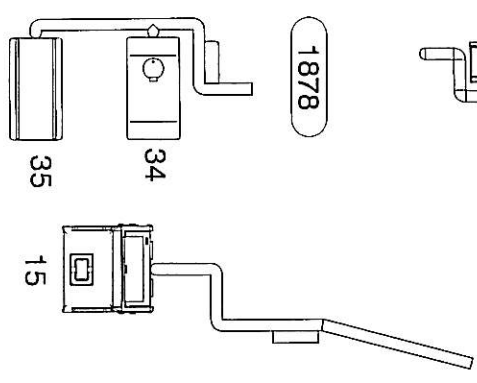
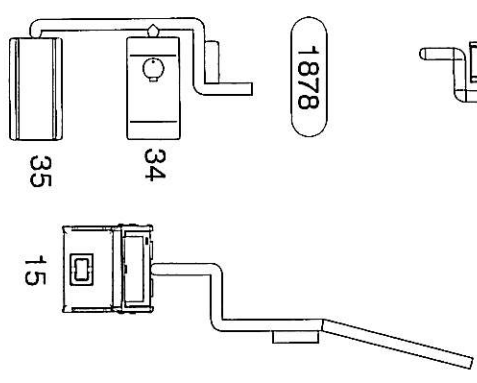
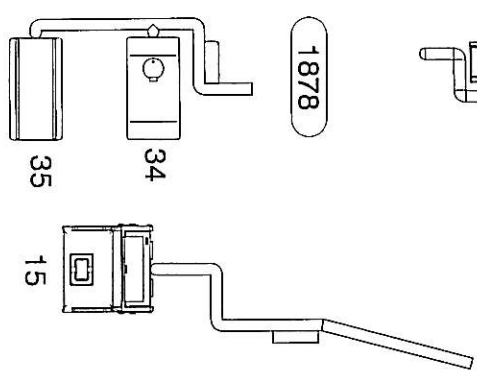
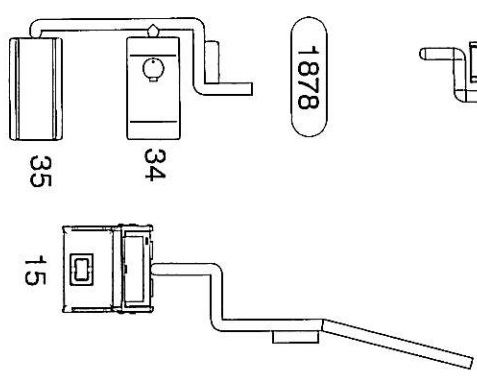
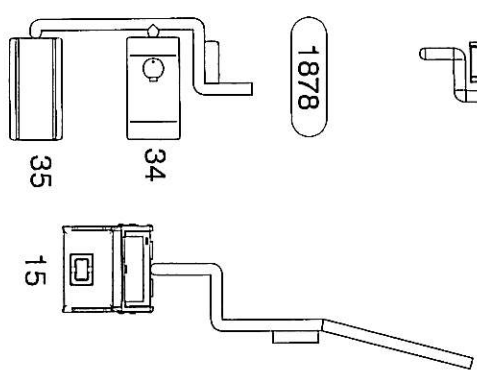
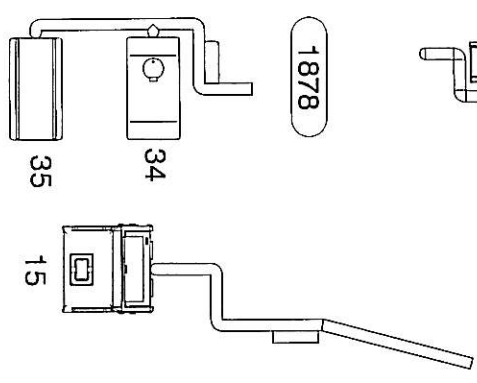
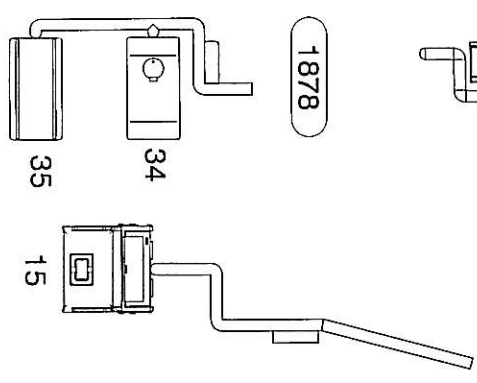
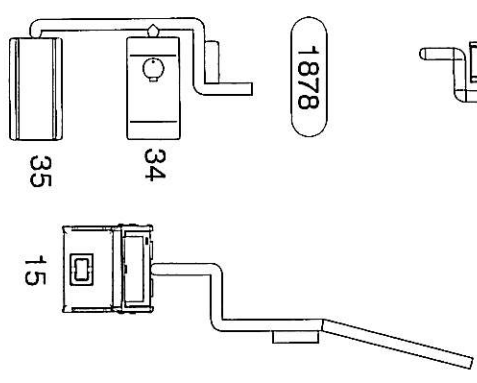
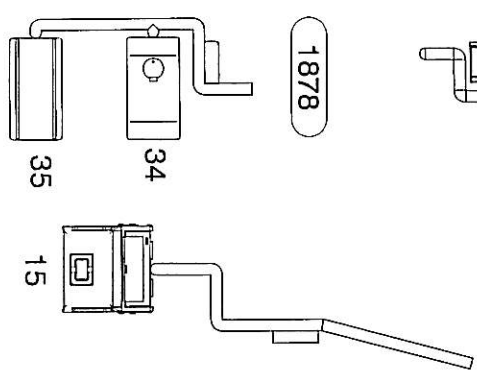
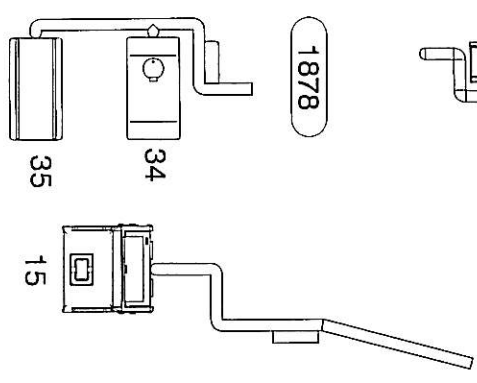
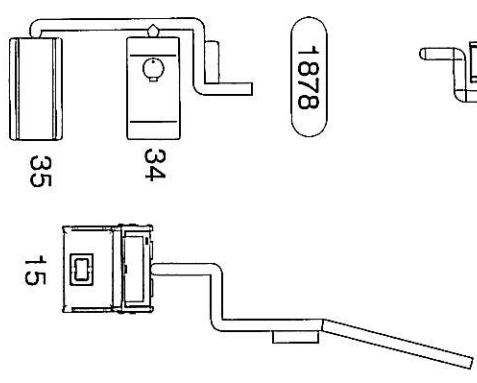
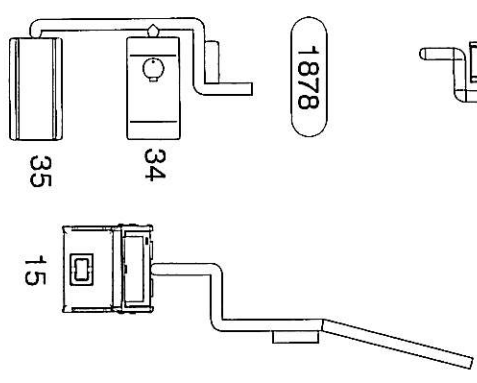
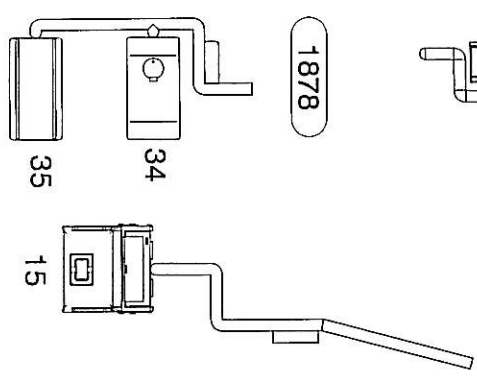
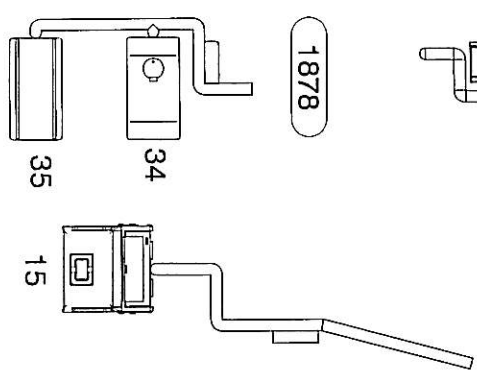
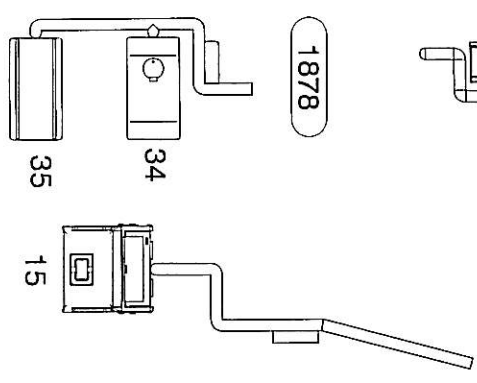
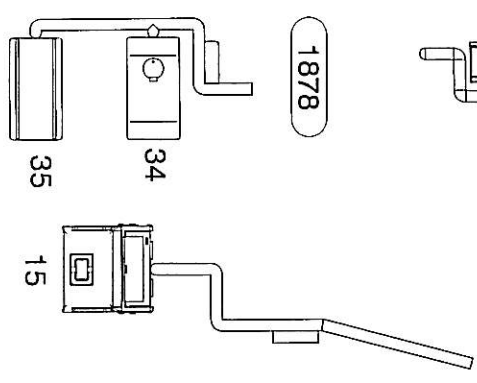
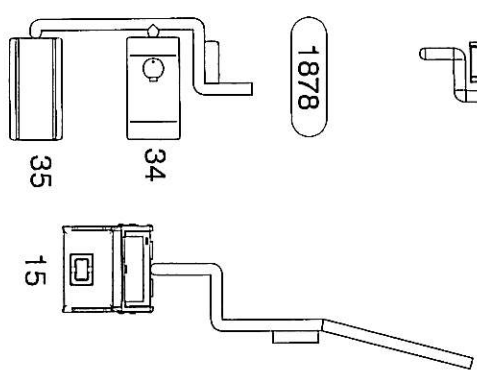
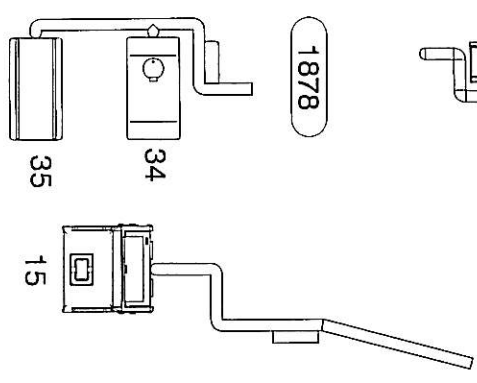
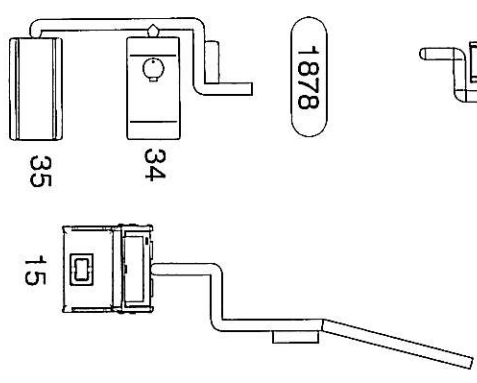
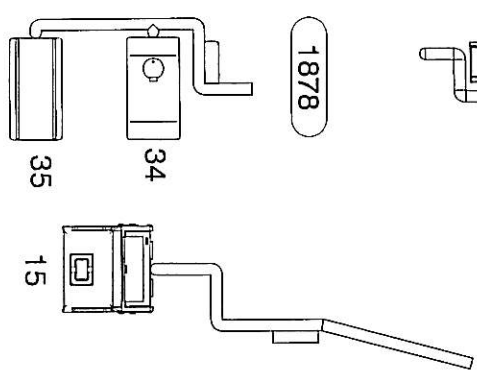
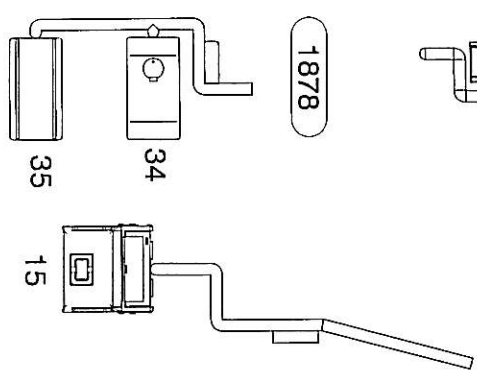
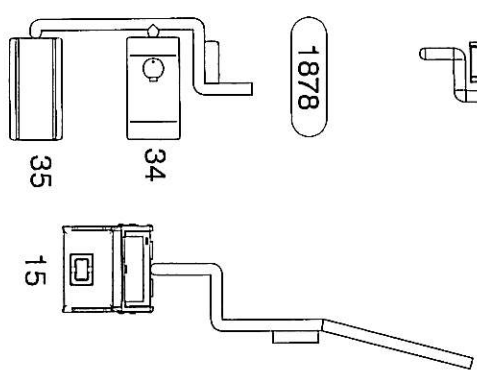
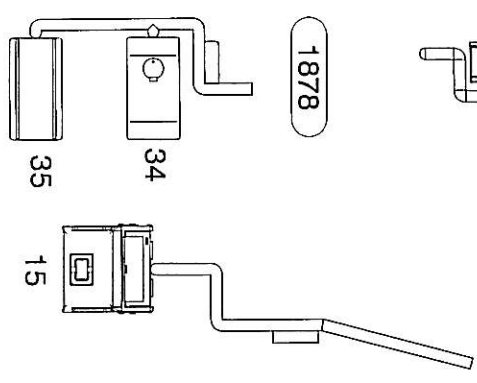
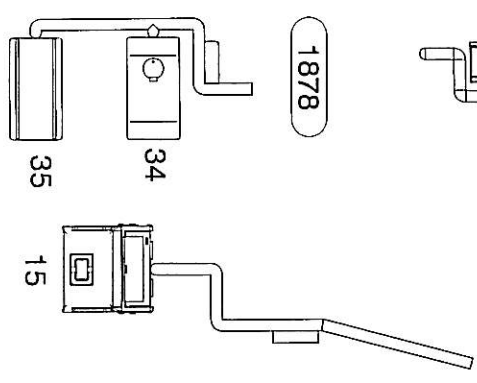
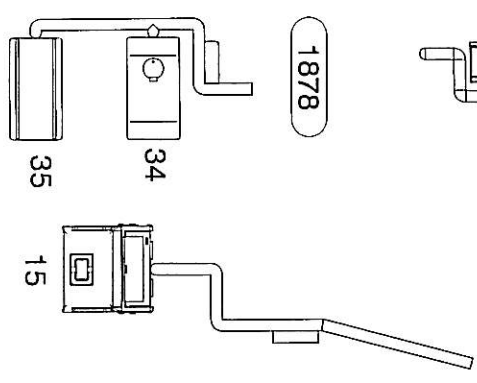
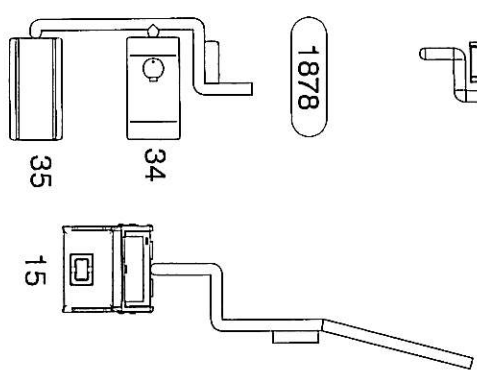
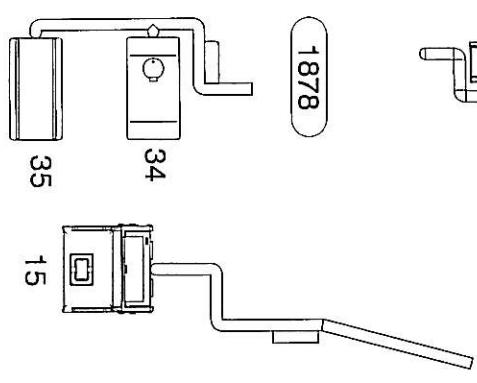
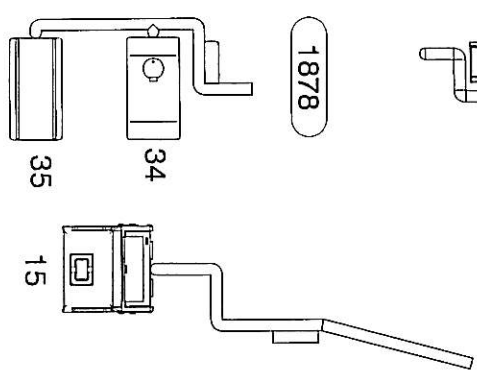
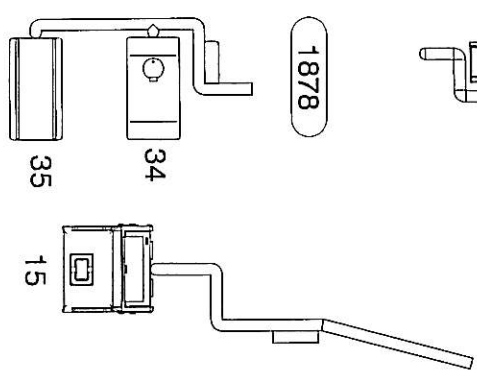
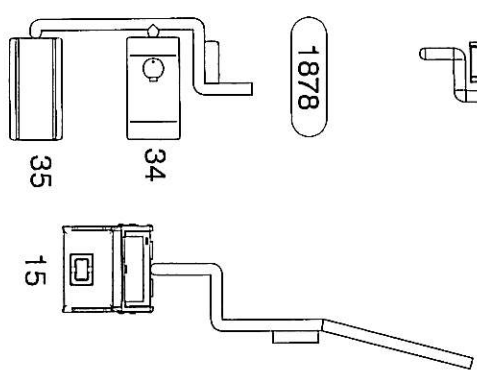
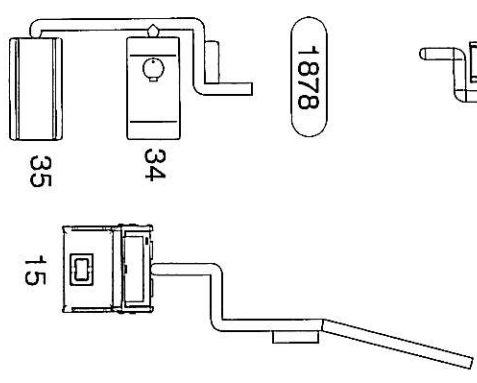
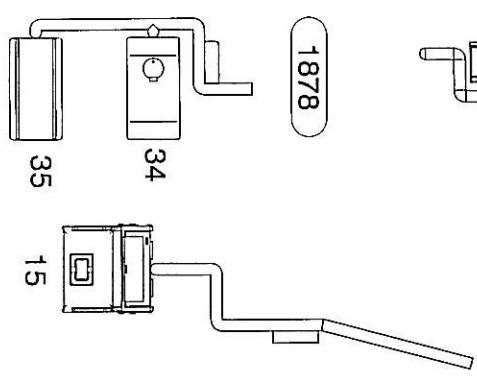
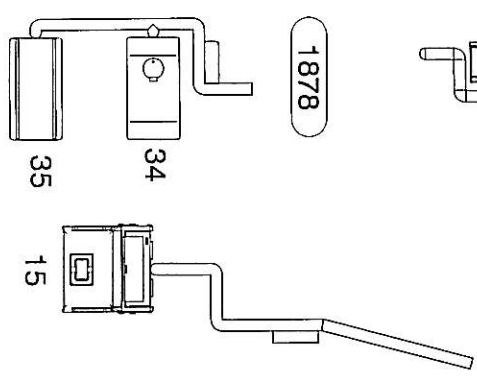
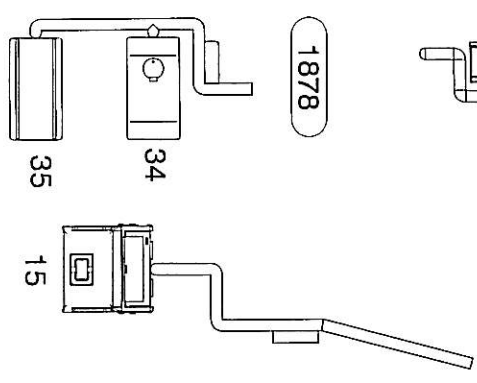
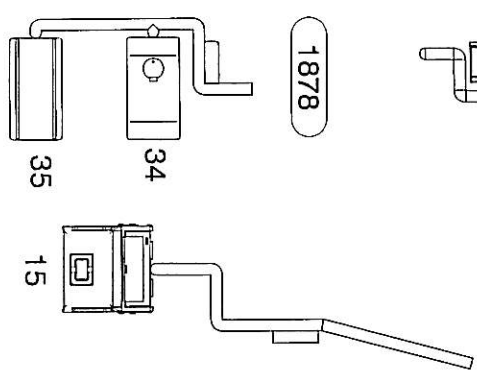
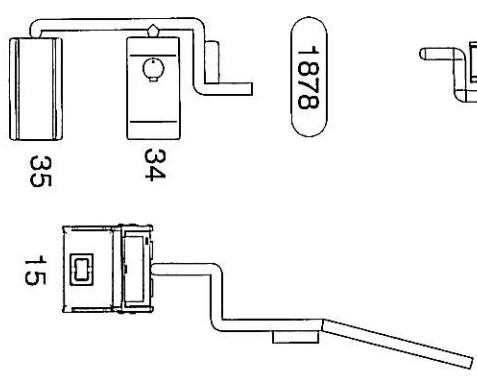
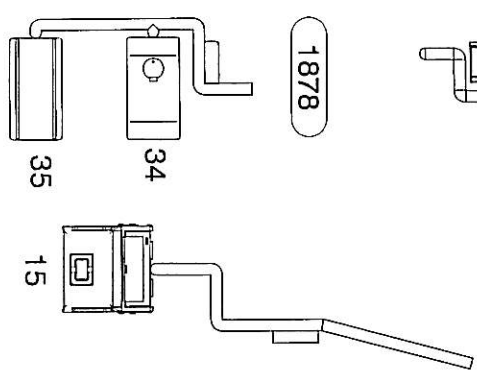
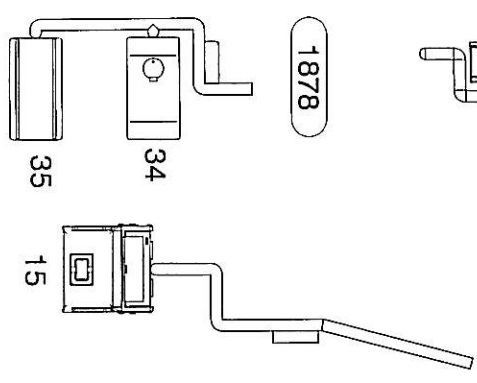
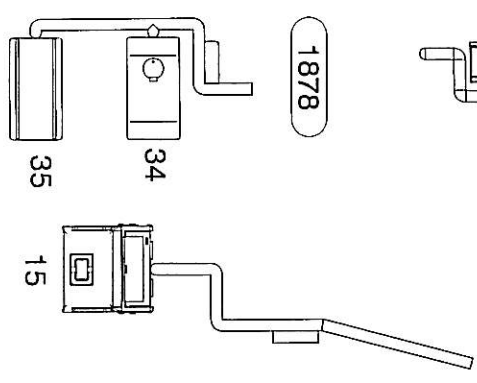
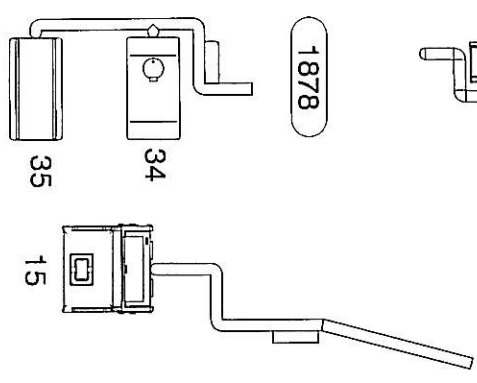
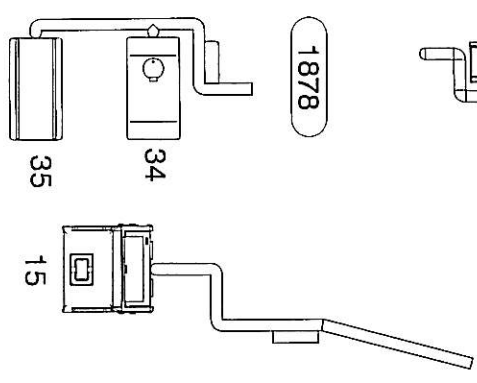
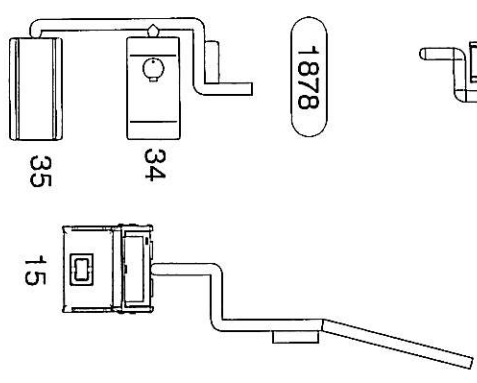
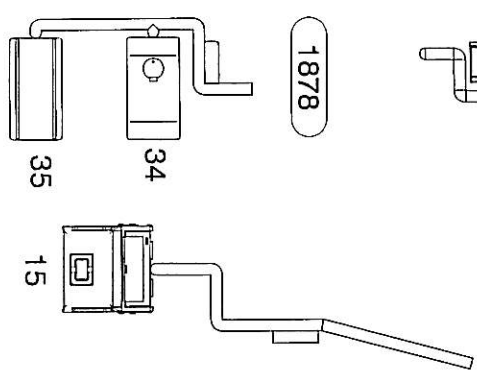
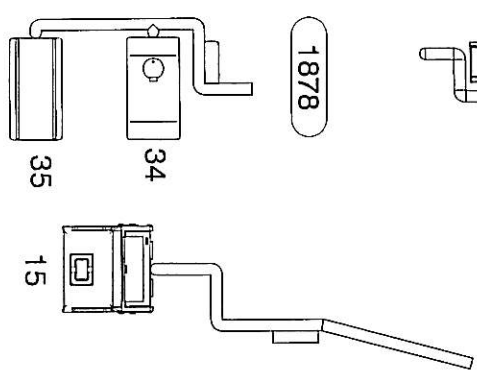
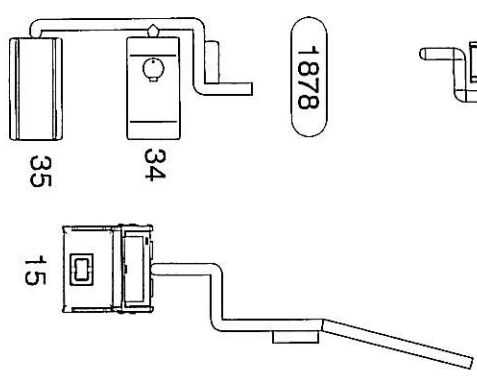
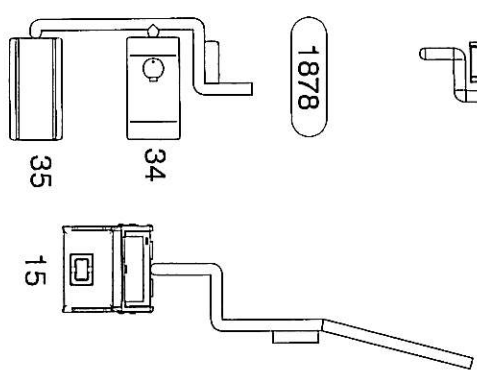
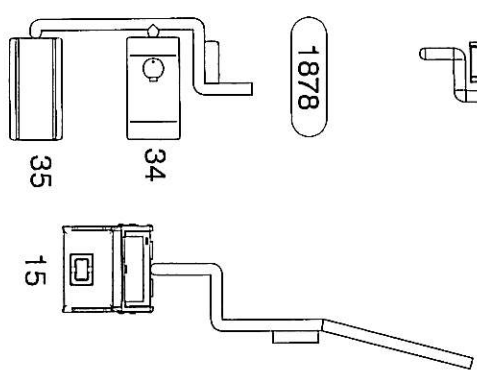
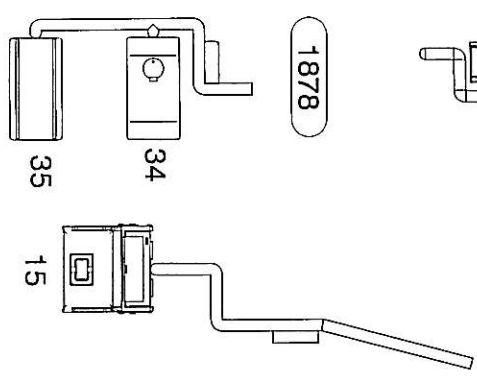
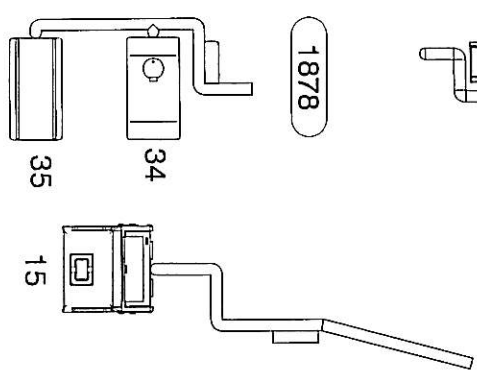
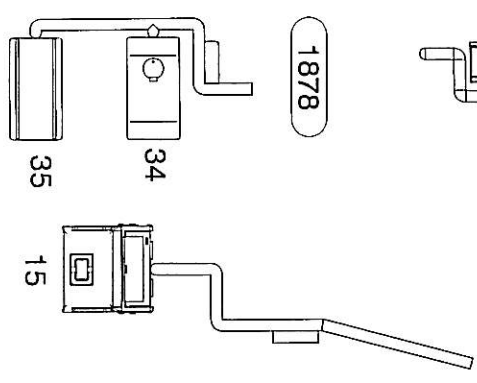
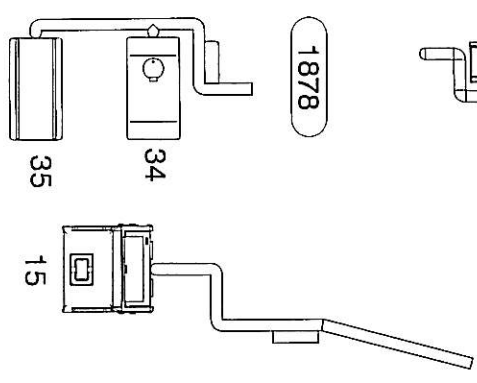
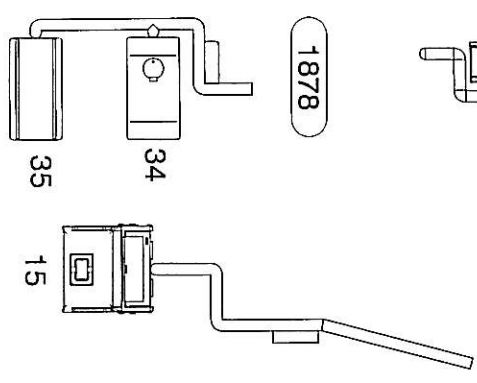
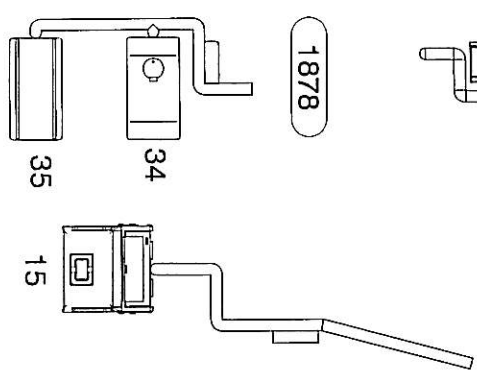
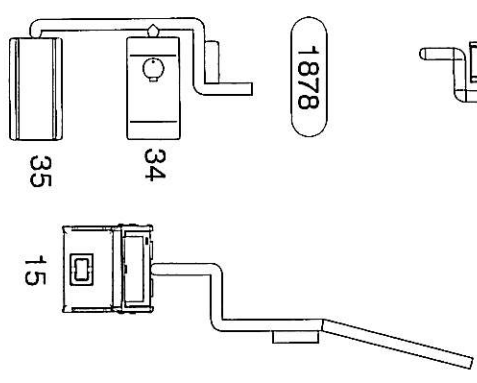
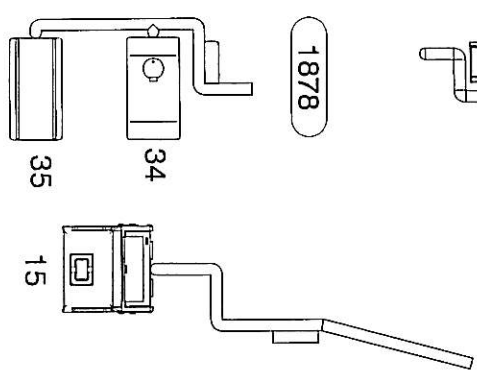
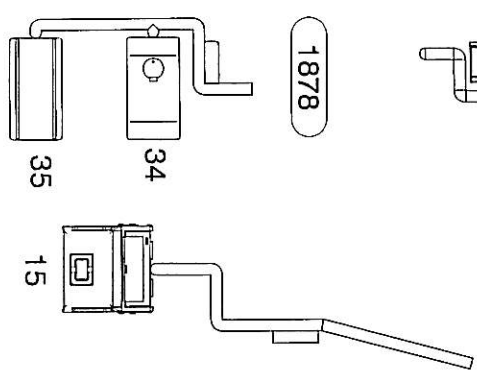
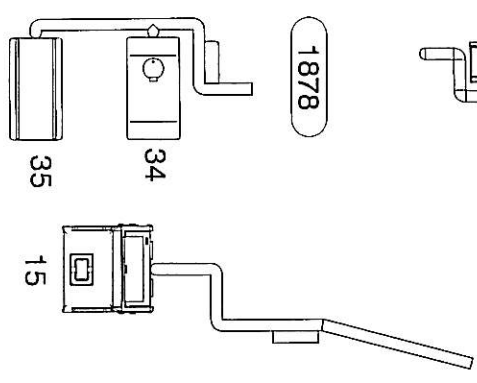
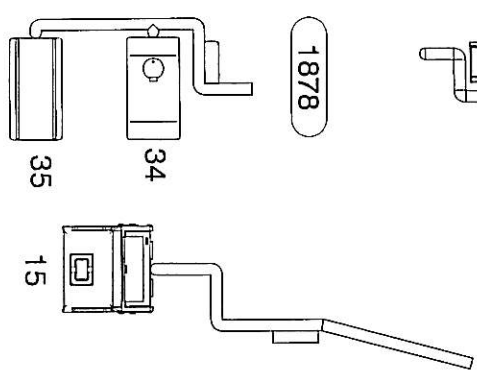
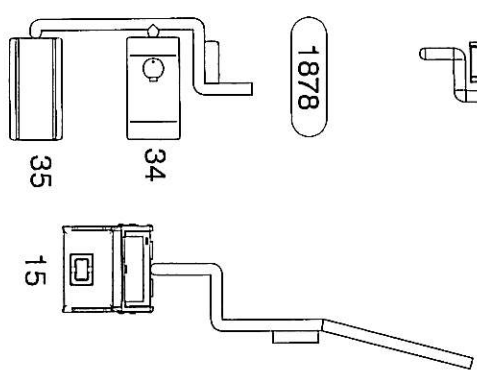
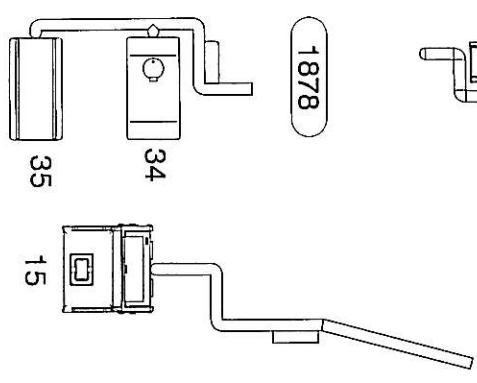
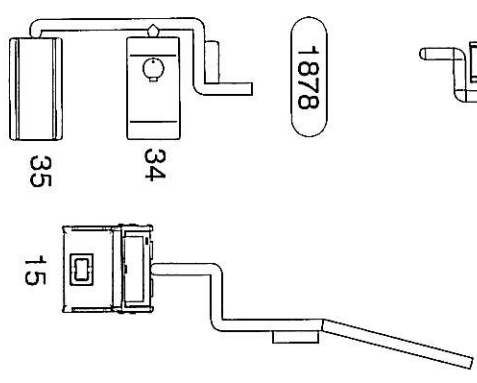
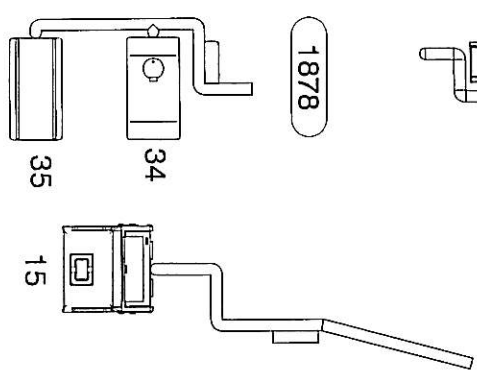
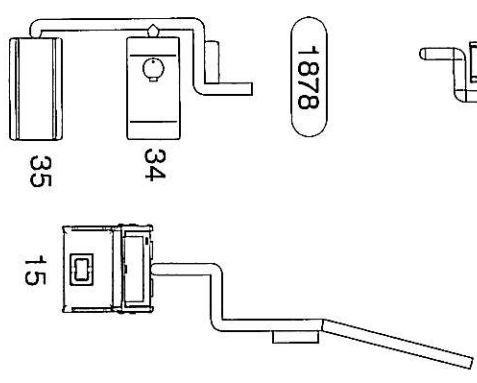
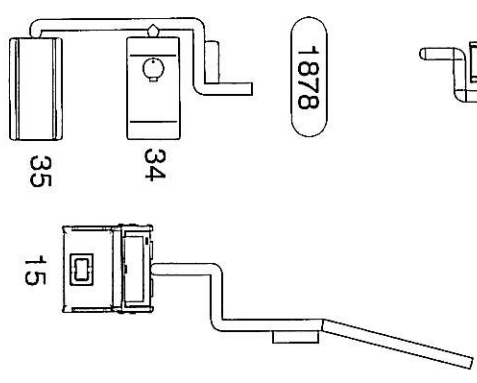
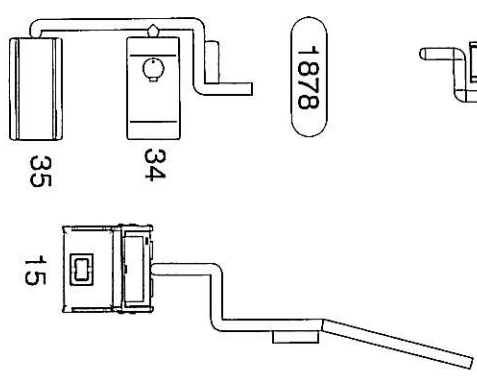
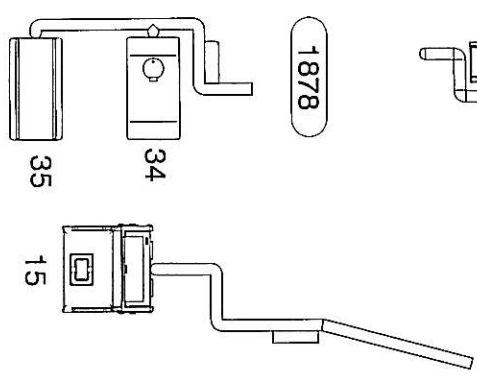
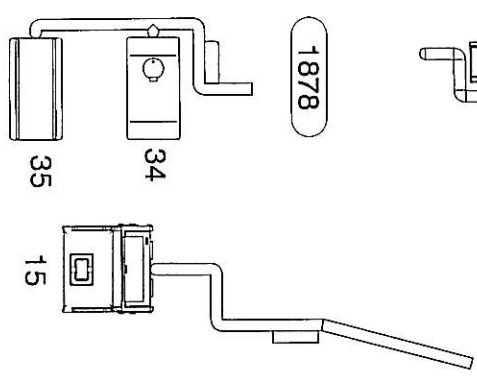
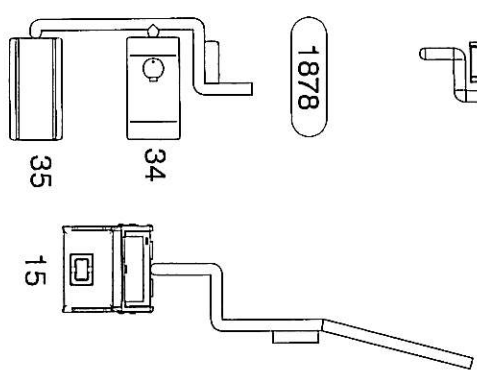
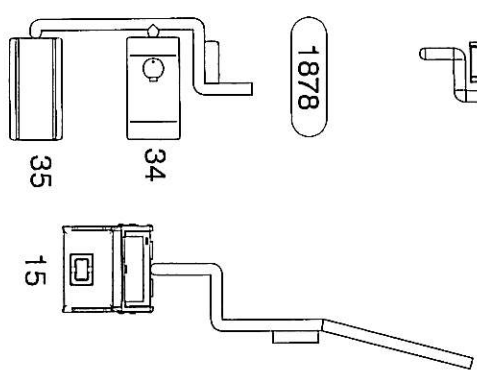
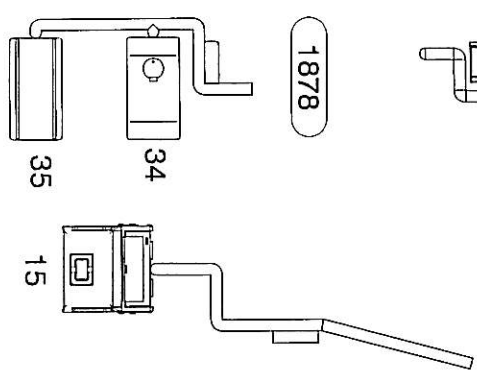
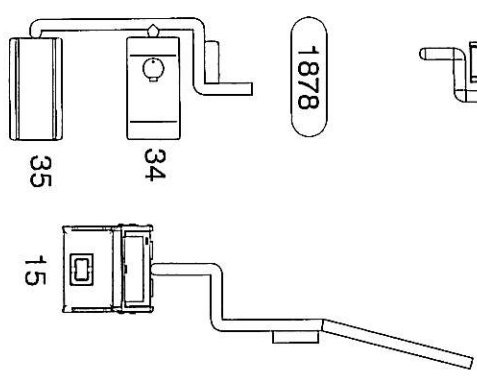
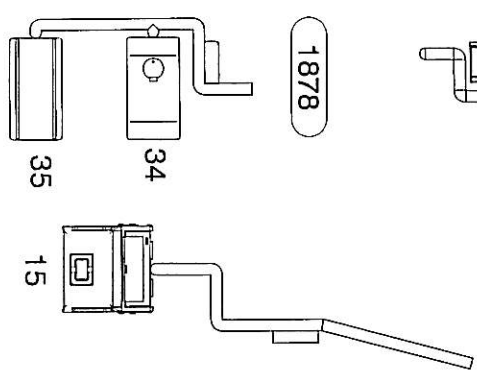
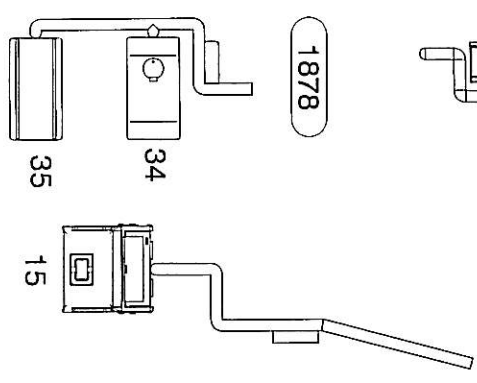
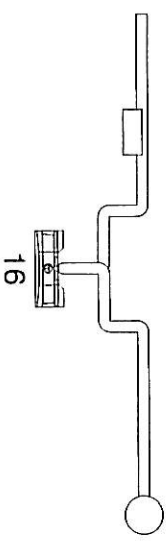

16303

C

1

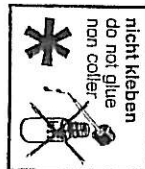
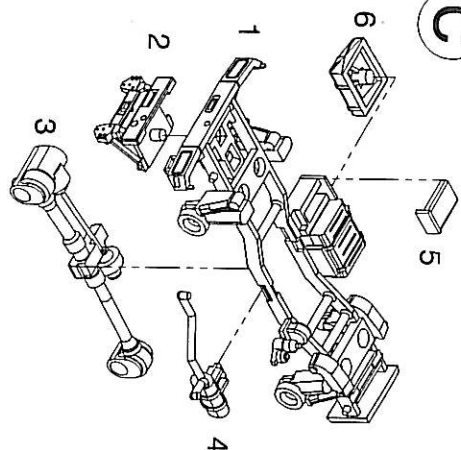

2

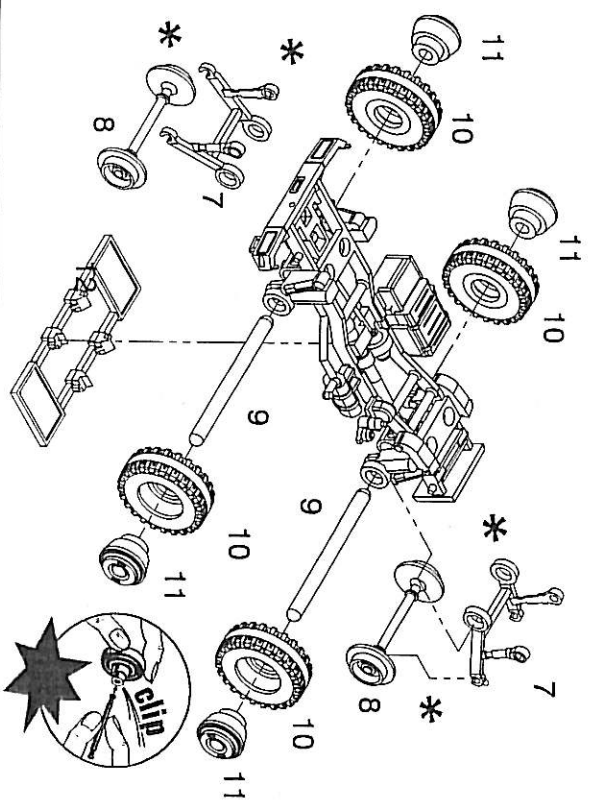

3

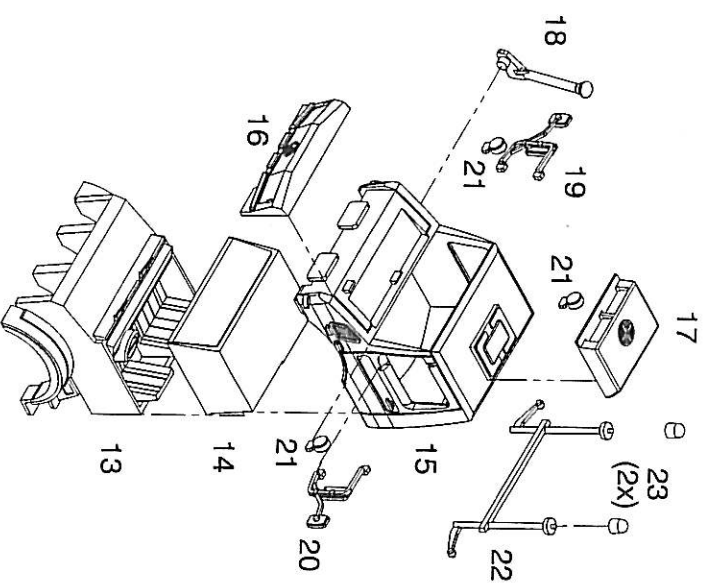

4

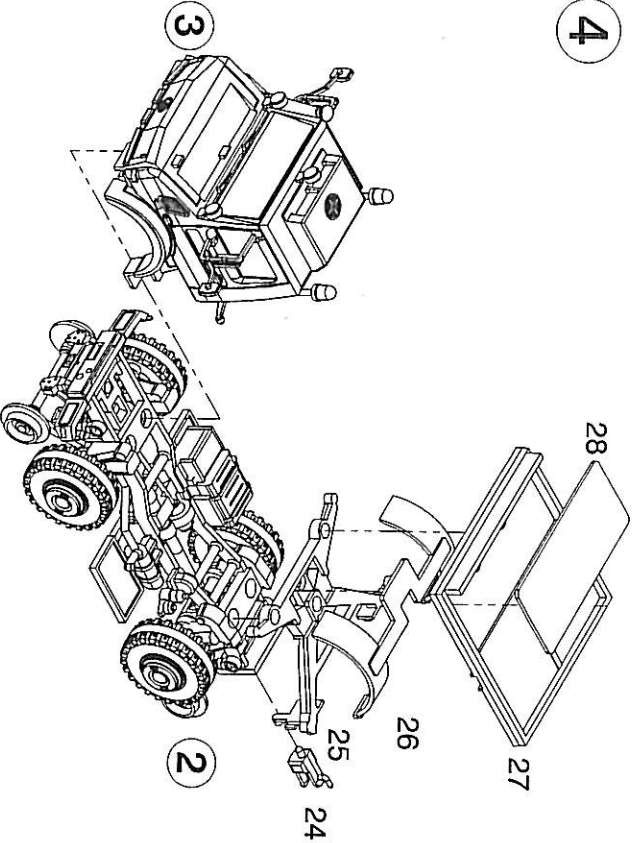

Kibri® - Spielwarenfabrik GmbH
Postfach 1540 · D-71005 Böblingen

