

Marktplatz "Miltenberg" mit Brunnen

Row of four period houses "Miltenberg" Place de marché "Miltenberg"

Dieser Bausatz wurde sorgfältig geprüft. Sollte dennoch ein Teil fehlen oder fehlerhaft sein, dann fordern Sie dieses bitte unter Angabe der Bausatz-, Spritzling- und Teilenummer, die aus der Bauanleitung hervorgehen, bei uns an. Um Übermittlungsfehler auszuschließen, können wir Ersatzteilanforderungen nur noch schriftlich entgegnehmen!

The contents of this kit have been carefully checked and thus should correspond with components as listed in the „Parts List“. Nevertheless, and in the event that a part / component is missing or is faulty, please request the necessary part, stating article, shot and part number as listed on the instruction sheet.

Cet article a été contrôlé avec soin. Si, malgré nos précautions, une pièce manque ou est défectueuse, veuillez nous la demander en précisant la référence de la maquette et le numéro de grappes et le numéro de la pièce, indiqués sur la notice de montage.

Das auf der Abbildung gezeigte Ausstattungsmaterial ist im Artikel nicht enthalten.
L'article est vendu sans le matériel de décoration figurant sur la photo.

Änderungen vorbehalten
Sous réserve de modifications

Subject to alterations
Made in Germany

Kibri® - Spielwarenfabrik GmbH
Hörschweiler Str. 1, D-72296 Schopfloch
www.kibri.com / info@kibri.com

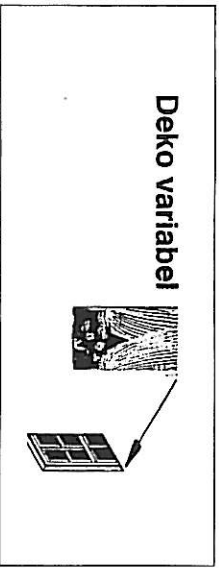

Deko variabel

Inhalt-contents-contenu
Hart.-Et. 116, 117, 118A, 118B, 119

Pos.	Stück	Pos.	Stück	Pos.	Stück	Pos.	Stück	Pos.	Stück	Pos.	Stück
E520	1	E563	1	E602	1	E647	1	E690	1		
E521	1	E564	1	E603	4	E648	1	E691	1		
E522	1	E565	1	E604	4	E649	1	E692	3		
E523	1	E566	1	E605	3	E650	1	E693	4		
E524	1	E567	1	E606	3	E651	1	E694	4		
E525	1	E568	1	E607	1	E652	1	E695	1		
E526	1	E569	1	E608	1	E652	1	E696	4		
E527	1	E570	1	E609	1	E653	1	E697	2		
E528	1	E571	1	E610	1	E654	4	E698	2		
		E572	1	E611	2	E655	1	E699	1		
E529	1			E612	3			E700	1		
E530	1	E573	1	E613	1	E656	1	E701	2		
E531	1	E574	2	E614	1	E657	1	E702	2		
E532	1	E575	1			E658	1	E703	1		
E533	1	E576	1	E620	1	E659	2	E704	2		
E534	1	E577	1	E621	1	E660	4	E705	1		
E535	1	E578	1	E622	1	E661	1	E706	1		
E536	1	E579	4	E623	1	E662	3	E707	4		
E537	1	E712	1	E624	2	E663	1	E719	1		
E538	1	E713	1	E625	1	E667	1				
E539	1	E715	1	E626	1	E668	1	E720	1		
E540	1	E716	1	E710	1			E721	1		
E541	1	E717	1	E711	1	E669	4	E722	1		
E542	1	E718	2	E626	1	E670	2	E723	1		
E543	1			E627	1	E671	2	E724	1		
E544	1	E582	1	E628	1	E672	1	E725	1		
E545	1	E583	1	E629	1	E673	1	E726	1		
E546	1	E584	1			E674	2	E727	1		
		E585	1	E630	1	E675	1	E728	1		
E547	1	E586	3	E631	1	E676	1	E729	1		
E548	1	E587	1	E632	4	E677	1	E730	1		
E549	2	E588	1	E633	1	E678	1	E731	1		
E550	2	E589	1	E634	2	E679	1	E732	1		
E551	2	E590	1	E635	2	E680	2				
E552	2	E591	2	E636	6	E681	2	E733	1		
E553	2	E592	1	E637	1	E682	2				
E554	2	E593	1	E638	1	E683	2				
E555	2	E594	1	E639	1	E684	2				
E556	1	E595	1	E640	2	E685	3				
E557	1	E596	1			E686	6				
E558	1	E597	1	E641	1	E687	1				
		E598	2	E642	1	E688	1				
E559	1	E599	1	E643	1	E689	4				
E560	1	E600	1	E644	6						
E561	1	E601	1	E645	1						
E562	1	E714	1	E646	1						
E615	1										
E616	1										

Bitte beachten!
Beim Zusammenbau die Reihenfolge der Bauabschnitte einhalten! Benötigtes Teil mit einem Seitenschneider bzw. Modellbaumesser vom Spritzbaum abtrennen und entgraten. Vorsicht Verletzungsgefahr!

Kleben nur mit Kibri-Plastikleber Nr. 9995.
Andere Klebstoffe können zu Verformungen der Kunststoffteile führen.

Da Spritzlinge für mehrere Artikel verwendet werden, kann es sein, dass bei diesem Bausatz einige Teile übrig bleiben.

Please note!

When building this kit, please keep to the sequence of construction step as shown. Individual pieces should be separated from the sprue using cutters or a hobby knife, removing any flash at the same time, talking care not to injure yourself when doing so.

Use only Kibri plastic adhesive No. 9995.

Other adhesives may deform the plastic pieces!
As each sprue may be used in several different kits, it may well be that some pieces will not be required for this kit.

Attention!

Veillez à bien respecter l'ordre d'assemblage des pièces ! Détachez les pièces nécessaires du jet et laissez convenablement la découpe au moyen d'un stamley. Attention de ne pas vous couper !

Ne collez qu'avec la colle plastique Kibri N° 9995.

L'utilisation d'autres colles peut entraîner une déformation des pièces synthétiques !

Etant donné que certains jets sont utilisés pour plusieurs articles, il est possible que cette boîte de construction contienne quelques pièces excédentaires.

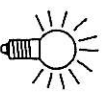

Soll das Modell beleuchtet werden, benutzen Sie bitte - nachdem die Fenster mit Deko-Gardien beklebt worden sind - das schwarze Papier, um die verbleibenden Freiflächen der Wände und Ecklugen abzudecken. Auf diese Weise kann ein „Durchschein“ der Beleuchtung außerhalb des Fensterbereiches vermieden werden.

If you wish to light up the model, then - once you have glued in position all the curtains around the windows - use the black paper to cover up the remaining walls, roof and corner areas. This will prevent the lighting from "Shining through" and only the windows will be illuminated.

Au cas ou vous équiperiez votre modèle d'un éclairage intérieur, placez le papier noir derrière les tentures afin de couvrir les fissures éventuelles qui pourraient apparaître dans les murs ou les coins, de sorte que la lumière ne reste visible qu'au travers des fenêtres.

1

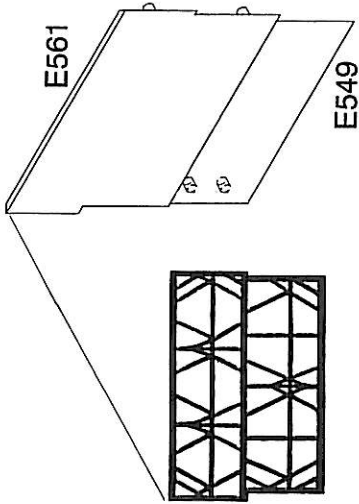

2

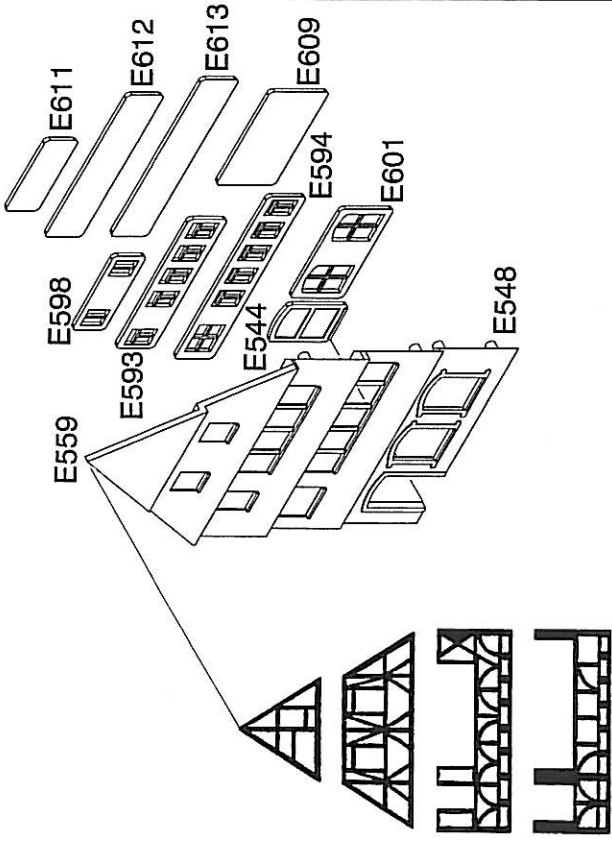

3

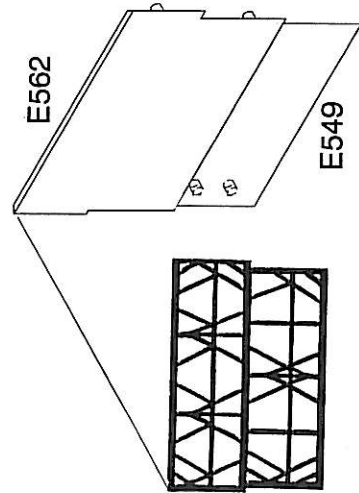

4

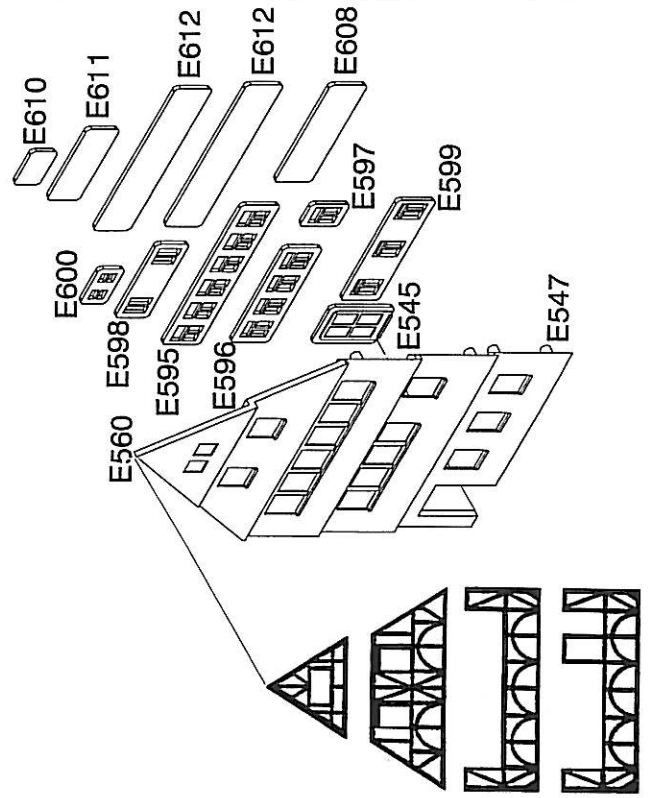

5

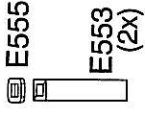

6

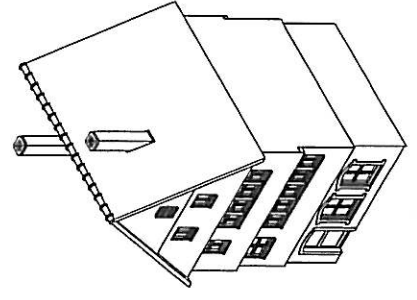
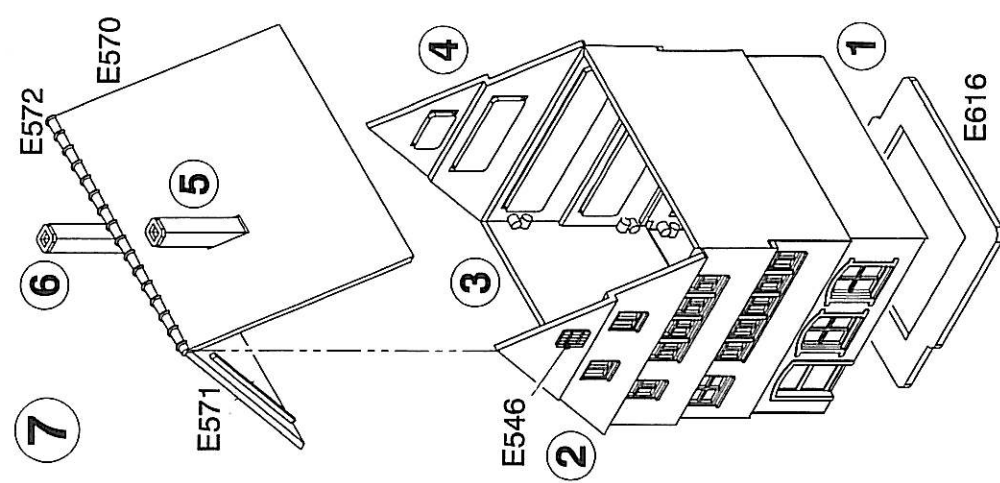
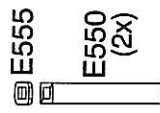

7102

C

Haft.Et.116

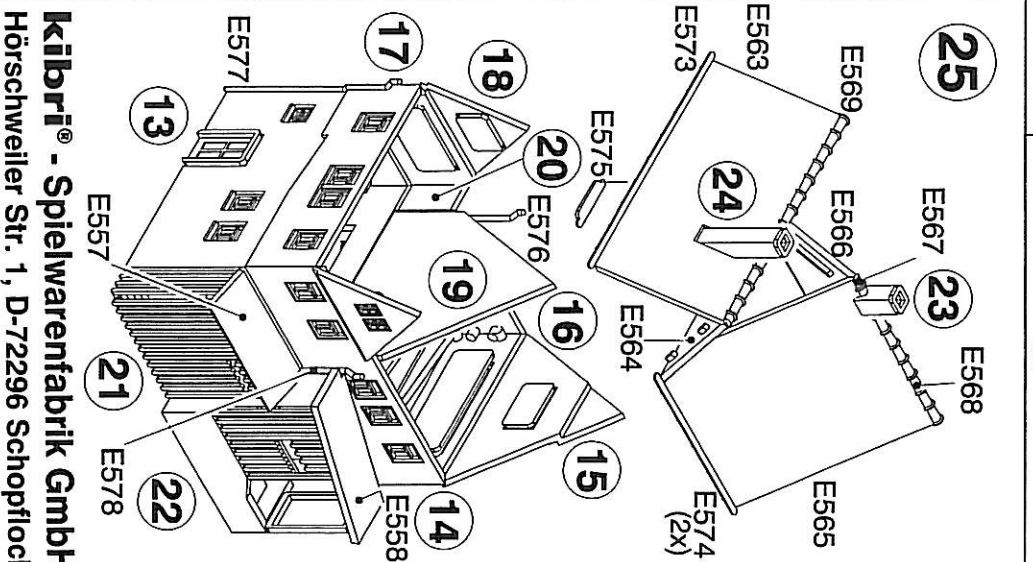
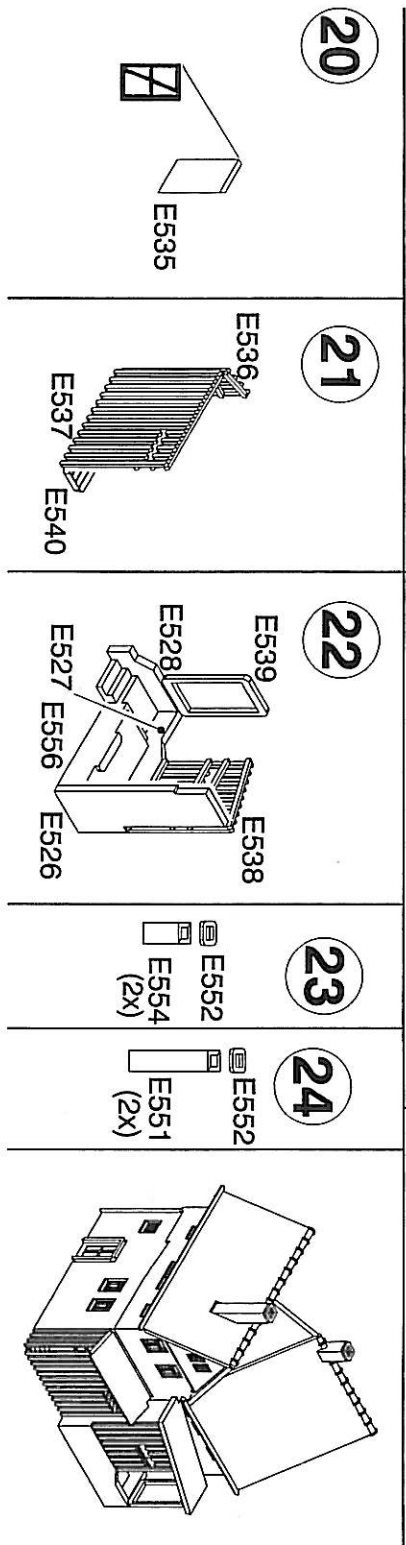
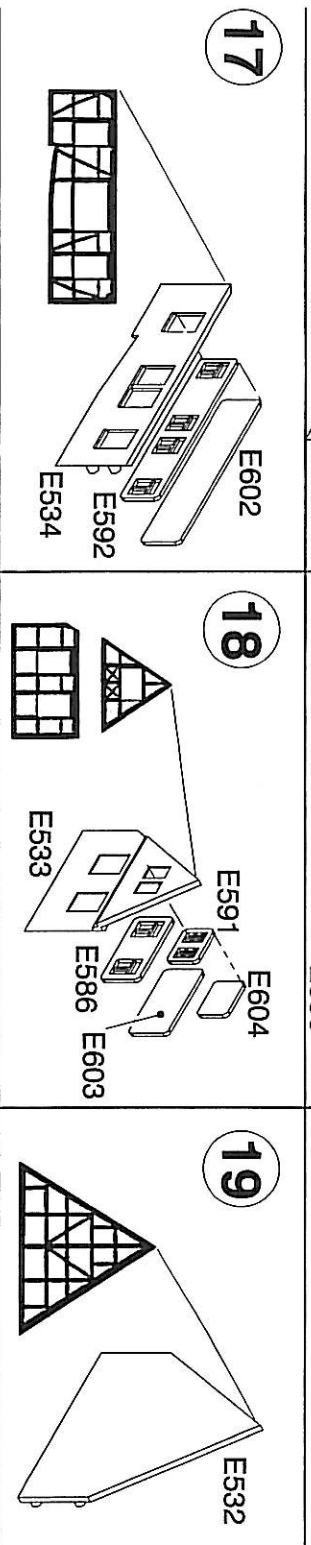
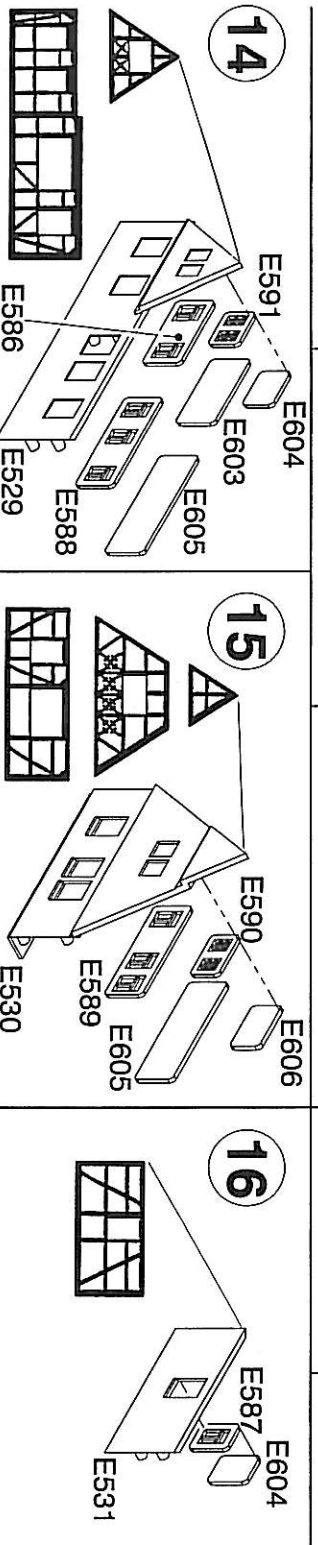
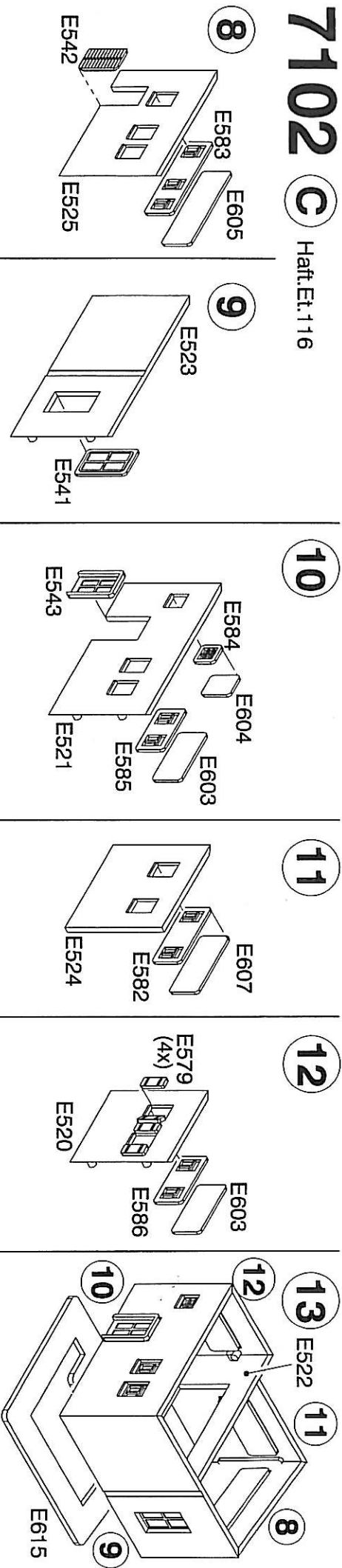

7102 D

Haft.Et.119

